



User Guide

GL10-RTU-ECTA

EtherCAT Communication Module



19011107 A00

1

1. Overview

Thank you for purchasing the GL10-RTU-ECTA EtherCAT communication module developed and manufactured independently by Inovance. GL10-RTU-ECTA is an EtherCAT bus slave expansion module used together with AM600 series medium-sized PLC main modules. It provides the automatic scanning function. Each GL10-RTU-ECTA module can connect up to 16 DI/DO modules, or 8 AI/AO modules. This guide describes the specifications, characteristics and using methods of this module. Read this guide carefully before using to ensure more safe usage. See the Medium-Sized PLC Programming Manual to understand the use of the user program development environment and design method of the user program of the product. You can download the latest materials from www.inovance.com.

2. Safety Information and Precautions

Safety information and precautions are identified into two grades: Warning and Caution. Please make sure to operate properly with adequate safety assurance.

WARNING Indicates the improper operation which, if not avoided, may cause death or serious injury;

CAUTION Indicates the improper operation which, if not avoided, may cause moderate or minor injury, as well as equipment damage.

In some cases, even failure to follow "Cautions" may also lead to serious consequences. Please make sure to follow both warnings and cautions, otherwise, it may cause death or serious injury, as well as product and relevant equipment and system damage. Please keep this guide well so that it can be read when necessary and forward this guide to the end user.

During control system design

- WARNING**
 - Provide a safety circuit outside the PLC so that the control system can still work safely once external power failure or PLC fault occurs.
 - Add a fuse or circuit breaker because the module may smoke or catch fire due to long-time overcurrent caused by operation above rated current or load short-circuit.

- CAUTION**
 - An emergency stop circuit, a protection circuit, a forward/reverse operation interlocked circuit, and a upper position limit and lower position limit interlocked circuit must be set in the external circuits of PLC to prevent damage to the machine.
 - To ensure safe operation, for the output signals that may cause critical accidents, please design external protection circuit and safety mechanism;
 - Once PLC CPU detects abnormality in the system, all outputs may be closed; however, when a fault occurs in the controller circuit, the output may not be under control. Therefore, it is necessary to design an appropriate external control circuit to ensure normal operation;
 - If the PLC's output units such as relays or transistors are damaged, the output may fail to switch between ON and OFF states according to the commands;
 - The PLC is designed to be used in indoor electrical environment (overvoltage category II). The power supply must have a system-level lightning protection device, assuring that overvoltage due to lightning shock can't be applied to the PLC's power supply input terminals, signal input terminals and output terminals and so forth, so as to avoid damage to the equipment.

During installation

- WARNING**
 - Installation must be carried out by the specialists who have received the necessary electrical training and understood enough electrical knowledge.
 - Disconnect all external power supplies of the system before module assembly/disassembly and wiring. Failure to do so may result in electric shock, module fault or malfunction. Failure to do so may result in electric shock, module fault or malfunction.
 - Do not use the PLC where there are dust, oil smoke, conductive dust, corrosive or combustible gases, or exposed to high temperature, condensation, wind & rain, or subject to vibration and impact. Electric shock, fire and malfunction may also result in damage or deterioration to the product.
 - The PLC is open-type equipment that must be installed in a control cabinet with lock (cabinet housing protection >IP20). Only the personnel who have received the necessary electrical training and understood enough electrical knowledge can open the cabinet.

2

CAUTION

- Prevent metal filings and wire ends from dropping into ventilation holes of the PLC during installation. Failure to comply may result in fire, fault and malfunction.
- Ensure there are no foreign matters on ventilation surface. Failure to comply may result in poor ventilation, which may cause fire, fault and malfunction.
- Ensure the module is connected to the respective connector securely and hook the module firmly. Improper installation may result in malfunction, fault or fall-off.

During wiring

WARNING

- Wiring must be carried out by personnel who have received the necessary electrical training and understood enough electrical knowledge.
- Disconnect all external power supplies of the system before wiring. Failure to comply may result in electric shock, module fault or malfunction.
- Install the terminal cover attached to the product before power-on or operation after wiring is completed. Failure to comply may result in electric shock.
- Perform good insulation on terminals so that insulation distance between cables will not reduce after cables are connected to terminals. Failure to comply may result in electric shock or damage to the equipment.

CAUTION

- Prevent dropping metal filings and wire ends drop into ventilation holes of the PLC at wiring. Failure to comply may result in fire, fault and malfunction.
- The external wiring specification and installation method must comply with local regulations. For details, see the wiring section in this guide.
- To ensure safety of equipment and operator, use cables with sufficient diameter and connect the cables to ground reliably.
- Wire the module correctly after making clear of the connector type. Failure to comply may result in module and external equipment fault.
- Tighten bolts on the terminal block in the specified torque range. If the terminal is not tight, short-circuit, fire or malfunction may be caused. If the terminal is too tight, fall-off, short-circuit, fire or malfunction may be caused.
- If the connector is used to connect with external equipment, perform correct crimping or welding with the tool specified by manufacturer. If connection is in poor contact, short-circuit, fire or malfunction may be caused.
- A label on the top of the module is to prevent foreign matters entering the module. Do not remove the label during wiring. Remember to remove it before system operation, facilitating ventilation.
- Do not bundle control wires, communication wires and power cables together. They must be run with distance of more than 100 mm. Otherwise, noise may result in malfunction.
- Select shielded cable for high-frequency signal input/output in applications with serious interference so as to enhance system anti-interference ability.

During maintenance & inspection

WARNING

- Maintenance & inspection must be carried out by personnel who have the necessary electrical training and experience.
- Do not touch the terminals while the power is on. Failure to comply may result in electric shock or malfunction.
- Disconnect all external power supplies of the system before cleaning the module or re-tightening screws on the terminal block or screws of the connector. Failure to comply may result in electric shock.
- Disconnect all external power supplies of the system before removing the module or connecting/removing the communication wirings. Failure to comply may result in electric shock or malfunction.

CAUTION

- Get acquainted with the guide and ensure safety before online modification, forcible output, and RUN/STOP operation.
- Disconnect the power supply before installing/removing the extension card.

At disposal

CAUTION

- Treat scrapped module as industrial waste. Dispose the battery according to local laws and regulations.

3. Product Information

Model and Nameplate

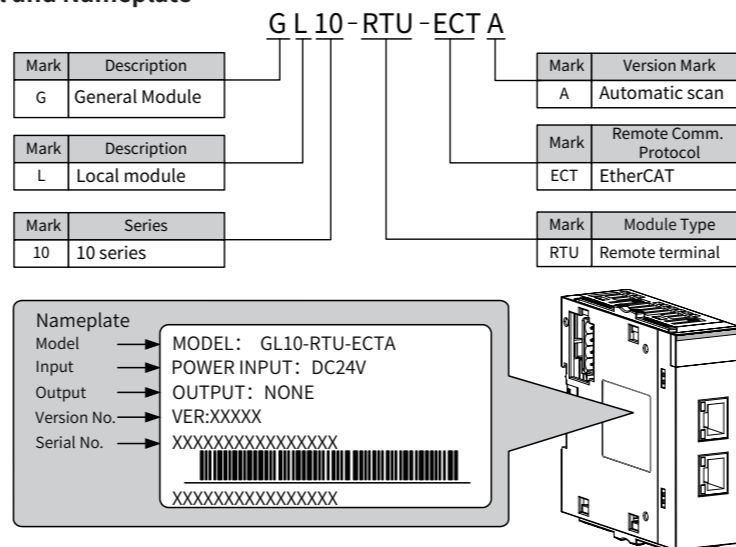

Figure 1 Description of model and nameplate

Model	Classification	Description	Applicable to
GL10-RTU-ECTA	EtherCAT communication module	CANopen protocol communication interface module	AM600

3

External Interface

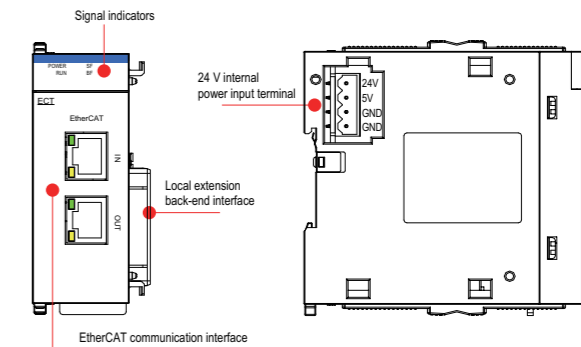

Figure 2 Diagram of EtherCAT communication module interface

No.	Interface Name	Function
1	IN	EtherCAT input interface
	OUT	EtherCAT output interface used to connect a back-end EtherCAT slave
2	Signal indicators	POWER Power indicator Green ON when power supply is switched on.
		RUN Indicator Green ON when the module is in normal operation
		SF Expansion bus error indicator Red ON when error occurs on the expansion bus
3	Local expansion module back-end interface	BF Communication error indicator Red ON when communication error occurs
		Connect back-end module
4	Internal 24 V power input terminal	Connect to power modules

General Specifications

Item	Specification
Power supply specifications	24 VDC (20.4 VDC to 28.8 VDC) (-15% to +20%)
Communication protocol	EtherCAT industrial real-time bus protocol
Maximum communication speed	Ethernet 100 Mbps
Network interface/Network Cable	Standard Ethernet interface and standard Ethernet cable (enhanced category 5 network cable) with a cable length of not more than 100 m
Station number range	1 to 125, the internal address is automatically arranged in the network bus connection sequence
Expandability of subsequent I/O modules	Can expand up to 16 IO modules. The actual number and configuration depend on each module's power consumption

Specific Performance Indexes Reached Are Shown in the Following Table:

Item	Specifications
Communication protocol	EtherCAT protocol
Application layer protocol	ETG.5001.1 S(D)V0.1.1
Supported service	CoE (PDO; SDO)
Physical layer	100BASE-TX
Baud rate	100 Mbit/s (100Base-TX)
Duplex mode	Full duplex
Topological structure	Linear topological structure
Transmission medium	For the network cable, refer to the "Wiring" section.
Transmission distance	Less than 100 M between two nodes
Number of slaves	Up to 125
EtherCAT frame length	44 to 1498 bytes
Process data	Single Ethernet frame up to 1486 bytes
Synchronization jitter of two slaves	< 1 us
Refresh time	1000 digital inputs/outputs: approximately 30 us About 100 us for 32 servo axes

4. Mechanical Design Reference

Mounting Dimensions

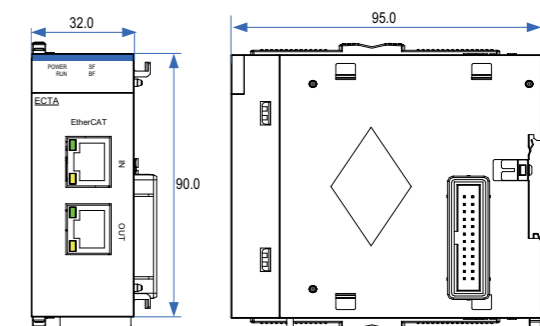

Figure 3 Mounting dimensions (in mm)

5. Electrical Design Reference

■ EtherCAT Communication Interface Description

The EtherCAT bus uses a standard RJ45 network interface and a standard connector.

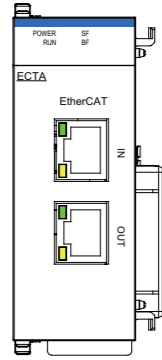

Figure 4 Terminal arrangement of the digital output module

■ Wiring

◆ Network cable preparing

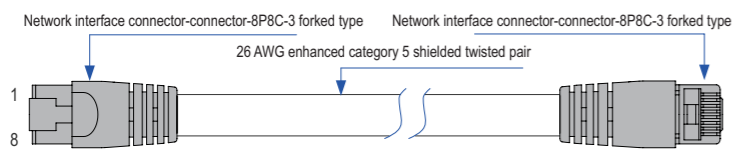

Figure 5 Requirements for EtherCAT network cable preparing

◆ Signal pin assignment

Pin	Signal	Signal Direction	Signal Description
1	RD+	Output	Data transfer+
2	TD-	Output	Data transfer-
3	RD+	Characteristic impedance of input and output port	Data receive+
4	--	--	Disabled
5	--	--	Disabled
6	RD-	Characteristic impedance of input and output port	Data receive-
7	--	--	Disabled
8	--	--	Disabled

◆ Length requirements:

FastEthernet technology demonstrates that the cable length between devices shall not exceed 100m when the EtherCAT bus is used. Otherwise, it will cause signal attenuation, affecting normal communication.

◆ Technical requirements:

There is no evidence of short circuit, open circuit, displacement or poor contact during the 100% continuity test. The EtherCAT bus transfers network data using shielded cables. Cables with the following specifications are recommended:

Item	Specifications
Cable type	Elastic crossover cable, S-FTP, enhanced category 5
Standard compliance	EIA/TIA568A, EN50173, ISO/IEC11801 EIA/TI Abulletin TSB, EIA/TIA SB40-A&TSB36
Conductor cross-section	AWG26
Conductor type	Twisted pair
Line pair	4

■ Communication Connection

1) Connection of RJ45 network cable

◆ Hold and insert the connector with cable into the RJ45 interface of the communication module until a clicking sound is made.

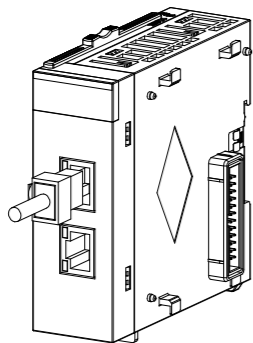

Figure 6 Diagram of network cable connection

◆ Disassembly procedures: Hold the connector tail mechanism to pull out the connector along a horizontal direction with the module.

2) Ethernet cable requirements:



Figure 7 Ethernet cable requirements

Please use enhanced category 5 shielded twisted pair with iron case molding line.

3) Requirements for securing communication cable

To avoid the influence on the communication cable due to other stresses and ensure communication stability, please secure the cable near the equipment before EtherCAT communication, as shown in the following figure:

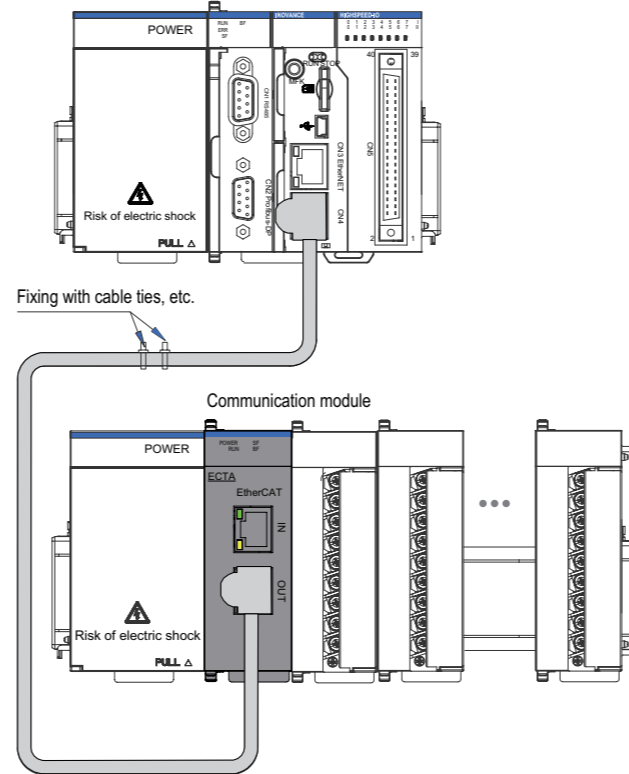

Figure 8 Necessary securing of communication cables near the equipment

LED Indicators	Description	Solution
RUN	OFF	There is no connection between the EtherCAT master and slave. Check configurations and parameter allocation; Check the communication address; Check whether the network specifications and length are consistent with the regulations.
	Flashing	The EtherCAT slave is in a state other than OP. Check slave configurations. Check whether the module is lost and fails or any unconfigured module exists.
BF	Flashing	There is no data exchange between the EtherCAT master and slave; EtherCAT communication receives non-executable state transition commands; ECTA module synchronization error occurs; Watchdog error occurs in EtherCAT communication. Check whether the connector is correctly inserted; Check whether the network cable is damaged; Restart the power supply; Check whether PDO configurations are correct.
	Flashing	Configuration error; Module error. Check whether upper computer configurations are consistent with module configurations; Check whether modules are disturbed.

6. Programming Examples

◆ Programming Example for AM600 main module + GL10-RTU-ECTA module + GL10-0016ETP module

Use the AM600 CPU module as the main control module and the GL10-RTU-ECTA module linked with the GL10-0016ETP module as the slave and set the first channel of two groups of outputs of the GL10-0016ETP to active; the usage of GL10-0016ETP is described as follows:

1) Create a project, enable the EtherCAT master function of the AM600, and add the GL10-RTU-ECTA module.

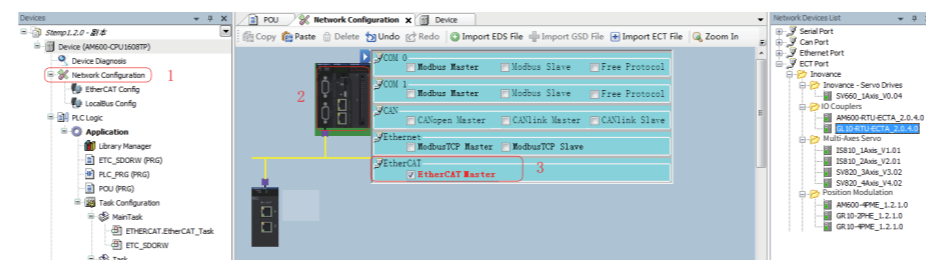

2) Add the GL10-0016ETP slave.

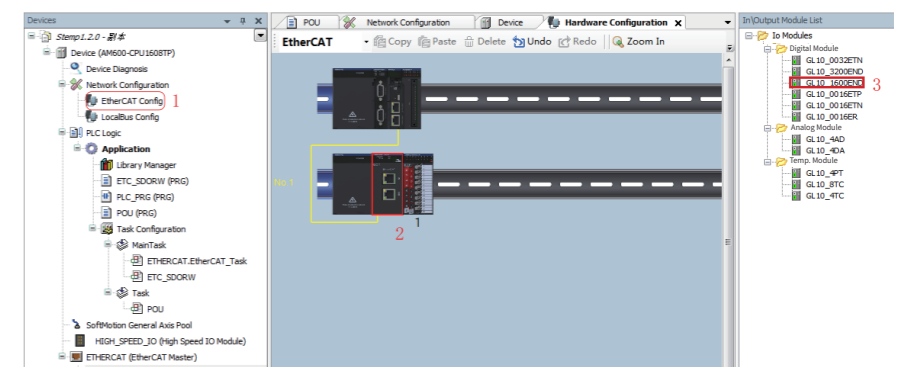

3) Program the GL10-0016ETP module using the ST language. Locate the channel mapping tags Q1_0 and Q2_0 and set their corresponding channel control to active.

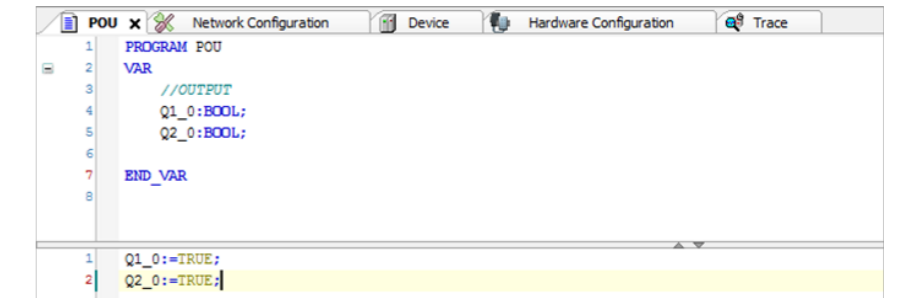

4) Map the mapping tags Q1_0 and Q2_0 defined in the program to the first channel of two groups of the GL10-0016ETP module respectively, shown in the following figure.

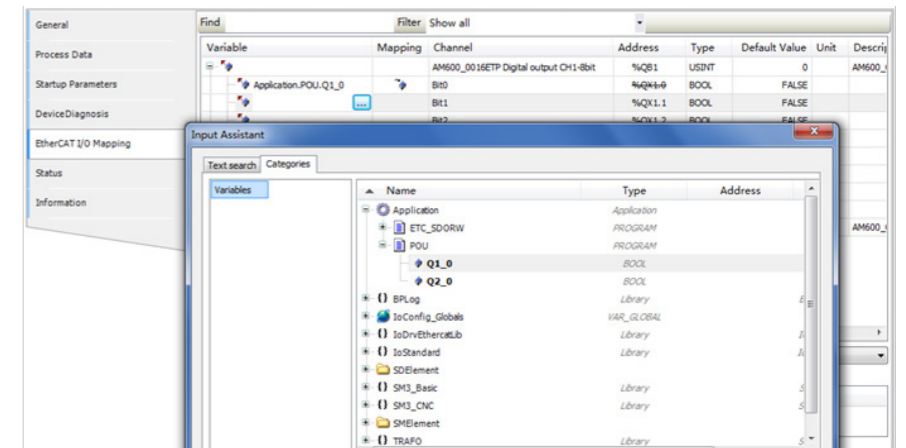

5) After successful compiling, download the project and run it.

INOVANCE Warranty Agreement

- Inovance provides an 18-month free warranty to the equipment itself from the date of manufacturing for the failure or damage under normal use conditions.
- Within the warranty period, maintenance will be charged for the damage caused by the following reasons:
 - Improper use or repair/modification without prior permission
 - Fire, flood, abnormal voltage, natural disasters and secondary disasters
 - Hardware damage caused by dropping or transportation after procurement
 - Operations not following the user instructions
 - Damage out of the equipment (for example, external device factors)
- The maintenance fee is charged according to the latest Maintenance Price List of Inovance.
- If there is any problem during the service, contact Inovance's agent or Inovance directly.
- Inovance reserves the rights for explanation of this agreement.

Suzhou Inovance Technology Co., Ltd.

Address: No.16, Youxiang Road, Yuexi Town, Wuzhong District, Suzhou 215104, P.R. China

Website: <http://www.inovance.com>