



User Guide

HD9X Series

Medium-voltage AC Drive



Preface

Thank you for purchasing the HD9X series medium voltage (MV) AC drive developed by Inovance.

The medium voltage HD9X with the high-performance vector control technology adopts the structure of power cells connected in series and reaches the maximum output voltage of 13.8 kV. It has the advantage of better control performance and is highly reliable.

The HD9X satisfies the requirements on energy saving and speed regulating of general-purpose machinery such as large and medium-sized fan and pump. It is widely applied in electrical systems, metallurgy, mine, building materials industry, petrochemical, and municipal construction.

This guide is a guideline for selection, installation, parameter setting, commissioning, maintenance & inspection of the HD9x. Before using the equipment, read this guide carefully to have a thorough understanding of the equipment. Keep the guide well and forward it to end users together with the equipment.

To ensure your safety, get acquainted with the functions of the equipment by reading the guide. If you have any problem concerning the functions or performance that is not described in the guide, contact the agent or the technical support personnel of Inovance to ensure correct use.



Note

- The drawings in the guide are sometimes shown without covers or protective guards. Remember to install the covers or protective guards as specified first, and then perform operations in accordance with the instructions.
 - The drawings in the guide are shown for description only and may not match the product you purchased.
 - The instructions are subject to change, without notice, due to product upgrade, specification modification as well as efforts to increase the accuracy and convenience of the guide.
 - If the guide is damaged or lost, order a replacement from your agent or the customer service center of Inovance.
 - Contact our agents or customer service center if you have any problem during the use.
-

■ Product Checking

Upon unpacking, check:

Item	Confirming Method
Whether the equipment is complete?	Check that no components or spare parts are missed according to the supply list.
Whether the equipment is consistent with the product you purchased?	Check the nameplate to confirm the equipment model and ratings.
Whether the equipment is damaged?	Check the appearance to see whether the product is damaged during transportation, for example, damage to cabinet appearance, deformation of cabinet doors and side panels.
Whether the equipment is moist?	Check whether the product suffered the rain during transportation. Rainwater seepage will cause component short-circuit or even damage to the product.
Whether the equipment is intact?	Open the cabinet doors and check the situations inside the cabinet. Check whether any control cable becomes loose, whether water seepage exists, and whether any component is missed or damaged.

If you find any problem with the product, or the product is not consistent with your order or it is damaged during transportation, contact your agent or Inovance immediately.

Note

The supply list includes the equipment components, spare parts, engineering drawings and the user guide.

If the HD9X is damaged during transportation, do as follows:

- Register the damage items when unloading. The register must be signed by the representative of the transportation company. Then submit a written report including the damage degree and estimated loss to the transportation company.
- Submit a written report on the non-obvious loss within the time contracted or notify the transportation company by fax or phone.
- Keep the damaged equipment well for the transportation company to check or for legal authority to perform necessary inspection. The loss is estimated by the transportation company.

■ Terms and Abbreviation

Term or Abbreviation	Meaning
d-q shaft	Synchronous rotational speed coordinate system.
Syn-transfer	Synchronous transfer
PWM	Pulse width modulation
I/O	Input/Output
AI	Analog input
AO	Analog output
DI	Digital input
DO	Digital output
EMC	Electro-magnetic compatibility
HMI	Human-machine touch screen
PID	Closed-loop: proportional-integral-differential

Contents

Preface	1
Chapter 1 Safety Information and Precautions.....	8
1.1 Safety Information	9
1.2 Safety Operations.....	10
1.3 General Precautions and Warnings.....	12
1.4 Design Standards	13
Chapter 2 Product Information	16
2.1 Designation Rules and Nameplate of the HD9X	16
2.2 Operating Principle and System Composition	17
2.3 Technical Specifications	22
2.4 Physical Appearance and Overall Dimensions of the HD9X	23
Chapter 3 Mechanical and Electrical Installation.....	28
3.1 Installation Requirements.....	28
3.2 Mechanical Installation	39
3.3 Electrical Installation.....	47
Chapter 4 Commissioning and Trial Running.....	68
4.1 Commissioning Procedure	68
4.2 Commissioning Precautions.....	69
4.3 Check Before Commissioning and Trial Running	70
4.4 Power-on Test of Control Cabinet.....	71
4.5 Power-on Test of AC Drive	72
Chapter 5 AC Drive Operations	76
5.1 Precautions Before Operation	77
5.2 Components on Cabinet Door.....	78
5.3 Local/Remote Switchover.....	79
5.4 AC Drive Running Mode	79
5.5 Alarm/Fault Reset	80
5.6 AC Drive Operation Procedure	80
Chapter 6 HMI Operation, Display and Applications	84
6.1 Monitor Interface.....	85
6.2 Pr. Setting.....	87

6.3 Trend Curve.....	93
6.4 Status/Alarm.....	95
6.5 Running Log.....	102
6.6 Sys. Property.....	104
6.7 HMI Operation Precautions.....	108
6.8 Starting or Stopping the AC Drive.....	109
6.9 Control of Frequency Reference of the AC Drive.....	111
6.10 Use of DI Terminals.....	113
6.11 Use of DO Terminals.....	113
6.12 Use of AI Terminals.....	114
6.13 Use of AO Terminals.....	114
Chapter 7 Function Parameter Table.....	116
7.1 Standard Parameters.....	116
7.2 Monitoring Function Parameters.....	125
Chapter 8 Description of Parameters.....	128
Group F0: Standard Parameters.....	128
Group F1: Motor 1 Parameters.....	135
Group F2: Motor 1 Vector Control Parameters.....	137
Group F4: Input Terminals.....	138
Group F5: Output Terminals.....	149
Group F6: Start/Stop Control.....	154
Group F8: Auxiliary Functions.....	156
Group F9: Protections.....	158
Group FA: PID Function.....	159
Group Fb: Fault Records.....	161
Group FC: Multi-Reference and Simple PLC Function.....	163
Group Fd: Communication.....	164
Group A6: AI Curve and Pulse Parameters.....	166
Chapter 9 Troubleshooting.....	170
9.1 System Alarms.....	170
9.2 System Faults.....	180
9.3 Power Cell Faults.....	196
9.4 Replacing Damaged Power Cells.....	199
Chapter 10 Routine Maintenance and Repair.....	202

10.1 Precautions During Inspection.....	202
10.2 Precautions on Operations.....	203
10.3 Daily Check.....	203
10.4 Periodical Repair and Maintenance.....	205
10.5 Disposal.....	207
Appendix A HD9X Modbus Communication Protocol.....	210
A.1 About the Protocol.....	210
A.2 Communication Data Format.....	212
A.3 Defination of Communication Parameter Addresses.....	215
Appendix B Extension DP Card (MD38DP2).....	217
B.1 Overview.....	217
B.2 Hardware Layout and Interface Descriptions.....	217
Appendix C Extension Encoder Cards.....	221
C.1 Overview.....	221
C.2 Physical Appearance.....	221
Appendix D Damage Notification Report.....	225
Version Change Record.....	226



Safety Information and Precautions

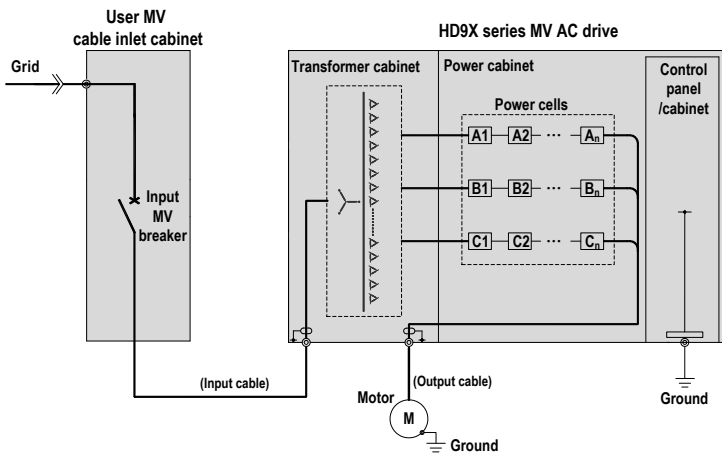
Chapter 1 Safety Information and Precautions

In this guide, the notices are graded based on the degree of danger:

- **⚠️ WARNING** indicates that failure to comply with the notice may result in personal injury or property damage.
- **⚠️ DANGER** indicates that failure to comply with the notice may result in severe personal injury or even death, or severe property damage.
- **⚡ ESD** indicates that failure to take ESD protections may result in electrical components damage and equipment fault.

Read the warnings on safety operations in this guide carefully before you use the HD9X series AC drive. Inovance will assume no liability or responsibility for any injury or loss caused by improper operation.

Figure 1-1 System cable inlet diagram



As shown in the preceding figure, an input MV breaker must be configured in the MV cable inlet cabinet to ensure safety.

1.1 Safety Information

Before wiring, equipment operation or maintenance, read the guide carefully to ensure correct use. When using the AC drive, make sure that you have been acquainted with the conditions of peripheral devices and related safety information.

Purpose

The HD9X is used only for the purpose of regulating the speed of three-phase MV asynchronous or synchronous motor, and cannot be used for other purposes.

About Wiring

- Only qualified personnel shall perform wiring under related safety code of the electric power industry.
- Always perform wiring after installation of the AC drive is complete.
- Strictly perform wiring according to the engineering drawings in the supply list.
- Make sure to ground the AC drive and the whole system well.
- Never connect the output terminals (U, V, W) of the AC drive to AC power.

About Operations

- Never run the AC drive with cabinet doors open or never open cabinet doors during drive running.
- Never operate the switch with wet hand.
- Never touch terminals of the AC drive at power-on.
- Never start/stop the AC drive by switching the circuit breaker on/off on the grid side.

1.2 Safety Operations

The HD9X series AC drive is applied to the power system of 3 to 13.8 kV. It is directly connected to medium-voltage grid. Therefore, follow the precautions below when working in or near the MV system.

- Wear insulated safety shoes before entering the MV system room to perform operations.
- Lay the insulation pad or rubber pad around the equipment.
- Always work with another person present.

Note

The product is only applicable to the power system of the voltage class stated in the technical protocol.

■ Check Before First-Time Power-On or After Maintenance

Checking Items

Check that screws of input and output terminals are tightened securely.

Check that cables for cabinets that are separately transported are connected properly and securely.

Check that all control cables and signal lines are connected properly and securely.

Check that all cabinets that are separately transported are grounded to the workshop reliably.

Check that cables for connecting power cells in series and neutral point cables are connected properly and securely.

■ Routine Check Before Power-On

Checking Items

Remove all temporary grounding protection before power-on.

Check whether the air filter needs to be replaced.

Check whether the faults of the AC drive have been handled properly.

Close and lock all cabinet doors.

■ Operations Before Power-OFF

Checking Items

Notify all persons involved to prepare for power-off.

Press the stop button to stop the AC drive.

Turn off the MV switch.

■ Maintenance and Inspection

Checking Items

Before any maintenance or inspection work, turn off the MV breaker and all isolation switches and meanwhile put a warning board to prevent sudden power-on.

Ensure that the AC drive is in the stop state and the MV presence indicator is OFF.

After medium voltage and low voltage are cut off, perform electrical inspection before any inspection work. For medium voltage inspection, use an electroscope of the corresponding voltage class and wear insulated safety articles.

After verifying that the AC drive is de-energized, tie the input three phases of the AC drive to ground to ensure your safety.

All parts of the AC drive which are liable to become energized must be grounded. When inspecting a bus knife switch, an isolation switch or a load switch in double-circuit system, pull down both bus knife switches and ground the inspected switch at both ends.

When installing a ground cable, make one end of the cable grounded first, and then attach the cable. When removing a ground cable, do in the reverse sequence. For either installation or removal, wear insulated personal protective equipment (PPE).

Attach the grounding cable to the place where the cable can be seen all the time and put a "Working" warning board at the grounding cable.

1.3 General Precautions and Warnings

The design of the HD9X drive takes full consideration of the safety during user operation. The drive may still have a hazardous voltage after power-off because the drive has built-in energy-saving capacitor in the power cells. In addition, some parts are too hot to touch. Therefore, obey the following rules when work at or near the drive.

DANGER

- Strictly follow the proper operation procedures before beginning any maintenance or inspection work.
- Maintain and inspect the AC drive only after verifying that it has been de-energized and become cool.
- Follow standard safety precautions and local codes during equipment installation and wiring.
- Perform operations only after verifying that there is no voltage, because residual voltage may still exist after the input MV breaker is enabled.
- Use only instruments that comply with the voltage withstand requirement and keep the instruments well grounded.
- Be careful when measuring components inside cabinets. Prevent meter leads from shorting together or from touching other terminals.
- Only qualified personnel can install, inspect and maintain the AC drive.

WARNING

- Never switch off the control power while MV power is applied.
- Never store flammable materials, including equipment drawings and the user guide, in, on and near the MV cabinets.
- Use an even and flat truck to transport the AC drive for long distance and ensure that the installation pad is level. On snowy and rainy days, take proper rain-proof and snow-proof measures before transportation, such as, packing the AC drive with felt fabric.
- Ensure sufficient capacity ratings of the crane, cables and hooks when lifting the AC drive.
- Comply with local regulations and requirement when disposing failed components, such as capacitors.

ESD

The printed circuit boards (PCBs) and power cells contain components that are sensitive to electrostatic discharge (ESD). Remove static electricity first before handling or repairing these components, which must be done by qualified personnel. For removal of static electricity, obey the following rules:

- Wear an anti-static wrist strap.
- Transport static sensitive equipment in anti-static bags.
- When handling a PCB, hold the board by its edges.
- Never slide PCBs across any surface.
- When returning any component to Inovance for repairing, deliver it in anti-static pack.

1.4 Design Standards

Standard	Name
GB 156-2007	Standard voltage
GB/T 1980-2005	Standard frequencies
GB/T 2423.10	Environmental testing for electric and electronic products-Part 2: Test methods-Test Fc: Vibration (sinusoidal)
GB/T 4588.1-1996	Sectional specification: single and double sided printed boards with plain holes
GB/T 4588.2-1996	Sectional specification: single and double sided printed boards with plated-through holes
GB 7678-1987	Semiconductor self-commutated converters
GB 10233-2005	Basic testing method for low-voltage switchgear and control gear assemblies
GB12668.3-2003/IEC 61800-3:1996	Adjustable speed electrical power drive systems - Part 3: EMC product standard including specific test methods
GB/T 15139-94	General technical standard for electrical equipment structure
GB/T 13422-92	Power semiconductor converters Electrical test methods
GB 12326	Power quality-voltage fluctuation and flicker
GB 1094.1-1094.5	Power transformer
IEC 60076	Power transformer
GB 6450	Dry-type power transformers
GB/T 10228	Specification and technical requirements for dry-type power transformers
GB 17211	Loading guide for dry-type power transformers
GB/T 14549-1993	Quality of electric energy supply Harmonics in public supply network
GB/T 12668.4-2006/IEC 61800-4:2002	Adjustable Speed Electrical Power Drive Systems, Part 4: General Requirements-Rating Specifications for AC Power Drive Systems Above 1,000 VAC and Not Exceeding 35 kV
GB/T 3797-2005	Electrical control assemblies
GB/T 2900.18-2008	Electrotechnical terminology - Low voltage apparatus
GB/T 3859.1-1993	Semiconductor convertors-Specification of basic requirements
GB/T 3859.2-1993	Semiconductor convertors-Application guide
GB/T 3859.3-1993	Semiconductor convertors - Transformers and reactors
GB 4208-2008/IEC60529:1989	Degrees of protection provided by enclosure (IP code)
GB/T 16935.1-2008/ IEC60664-1:1992	Insulation coordination for equipment within low-voltage systems - Part 1: Principles, requirements and test
IEC 60721-3-1:1997	Classification of environmental conditions - Part 3: Classification of groups of environmental parameters and their severities- Section 1: Storage

Standard	Name
IEC 60721-3-2:1997	Classification of environmental conditions - Part 3: Classification of groups of environmental parameters and their severities- Section 2: Transportation
IEC 60721-3-3:2008	Classification of environmental conditions - Part 3: Classification of groups of environmental parameters and their severities- Section 3: Stationary use at weather protected locations
IEC 61000-2-4:2002	Electromagnetic compatibility (EMC) – Part 2-4: Environment; Compatibility levels in industrial plants for low-frequency conducted disturbances
IEC 61000-4-7:2002	Electromagnetic compatibility (EMC) - Part 4-7: Testing and measurement techniques - General guide on harmonics and inter-harmonics measurements and instrumentation, for power supply systems and equipment connected thereto
GB/T 13534-2009/IEC 60757:1983	Code for designation of colours
IEC Guide 106:1989	Guide for specifying environmental conditions for equipment performance rating



Product Information

Chapter 2 Product Information

2.1 Designation Rules and Nameplate of the HD9X

Figure 2-1 Designation rules of the HD9X

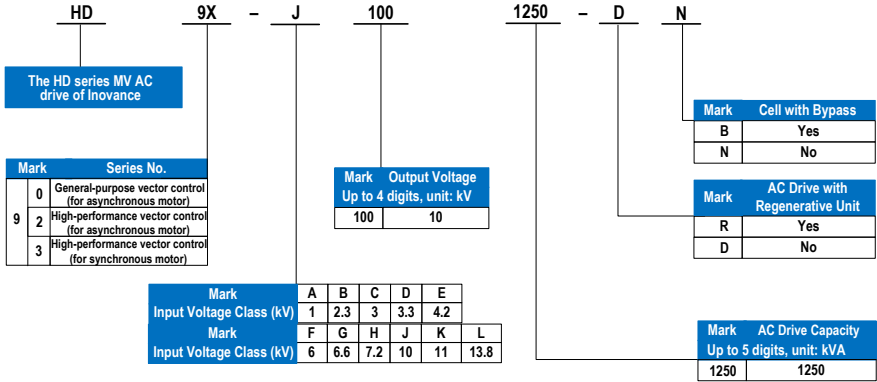
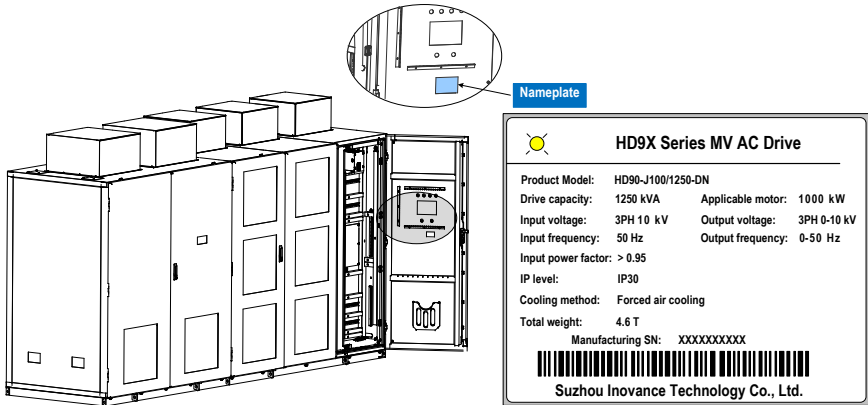


Figure 2-2 Nameplate of the HD9X



2.2 Operating Principle and System Composition

2.2.1 System Operating Principle

The HD9X series AC drive is a voltage source AC drive with power cells connected in series and direct medium voltage input and output. It contains three phase groups of power cells of the same quantity in series.

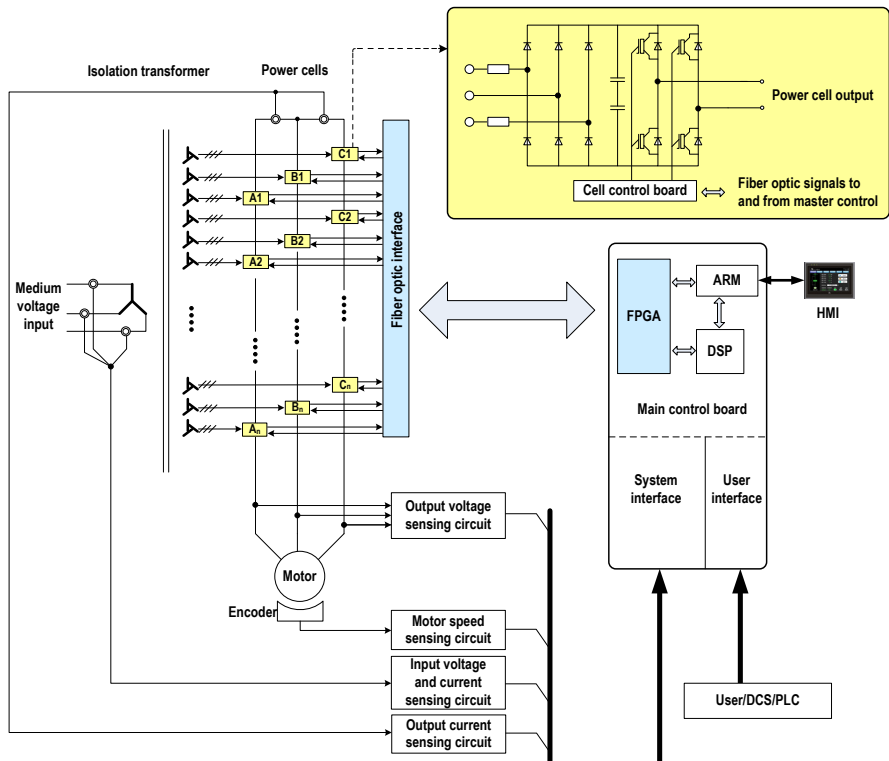
On the input side, the power cells are supplied power by the phase-shifting transformer whose secondary winding is multiple-structure and their electric angle is staggered.

Each power cell outputs voltage and frequency-variably AC power after three-phase full-bridge rectification by diode and inverting by single-phase IGBT. Power cells in a group are connected in series, form multi-ladder PWM wave, and directly provide three-phase Y-type MV line voltage to the motor.

The multi-pulse rectification technology of the HD9X can eliminate most of the harmonic currents drawn by the individual power cells, reduce harmonic pollution to the grid, and improve the power factor on the grid side. The multi-level output is close to sine wave, which greatly reduces the motor torque ripple.

The main control system and power cells transmit signals via optical fiber, thus avoiding electromagnetic interference and ensuring reliable transmission of the system control signals.

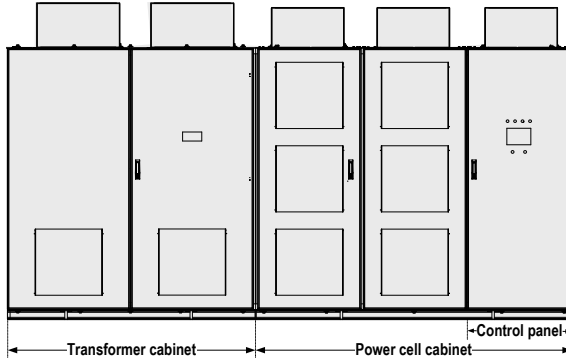
Figure 2-3 Topological structure of the HD9X



2.2.2 System Composition

The HD9X consists of a transformer cabinet, a power cell cabinet, a control panel/cabinet and a bypass cabinet (optional), as shown in the following figure.

Figure 2-4 System composition of the HD9X



■ Transformer cabinet

The phase-shifting transformer with class H insulation adopts the dry-type structure. Its base is fixed by screws to the cabinet base. A centrifugal fan is installed on the cabinet roof to cool down the transformer.

The transformer receives the three-phase medium voltage on the primary side (through the line-voltage bypass cabinet or MV inlet cabinet), and outputs three-phase low voltage on the secondary side to the power cells.

The temperature controller monitors the temperature of each phase of the transformer in real time and provides the functions of overtemperature alarm and fault. By default, when the transformer temperature exceeds 90°C, the system alarms. When the temperature exceeds 110°C, the system reports the overtemperature fault.

■ Power cell cabinet

The cabinet consists of 9, 15 or 24 power cells (3, 5 or 8 power cells in series per phase) to achieve output voltage of 3 kV, 6 kV and 10 kV, respectively. A centrifugal fan is installed on the cabinet roof to cool down the power cells. Each power cell is configured with a pair of fiber optics to communicate with the main control system.

■ Control panel/cabinet

When the output current of the AC drive is smaller than 200 A, the control part is embedded on the right side of the power cell cabinet. In this case, the control part is named control panel.

When the output current of the AC drive is larger than 200 A, the control part is inside an independent cabinet. In this case, the control part is named control cabinet.

The cabinet contains a control box, low-voltage power supply and interface components.

- The control box has the function of system control and state sampling.
- The low-voltage power supply and interface components provide you with the low-voltage power interface, system fan control and user signal interfaces.

The cabinet door contains the touch screen HMI, indicators, the remote/local switch and the emergency stop button.

■ Bypass cabinet (optional)

The bypass cabinet is purposed to transfer the motor to line-voltage control when a fault occurs on the AC drive, and transfer the motor to AC drive control when the AC drive resumes normal operation.

The bypass cabinet has two configurations: manual bypass cabinet and automatic bypass cabinet.

1. Manual bypass cabinet

There are three knife switches (QS1, QS2 and QS3) inside the manual bypass cabinet for the operator to perform manual switchover.

The physical appearance and overall dimensions of the manual bypass cabinet are shown in the following figure:

Figure 2-5 Physical appearance and overall dimensions of the manual bypass cabinet

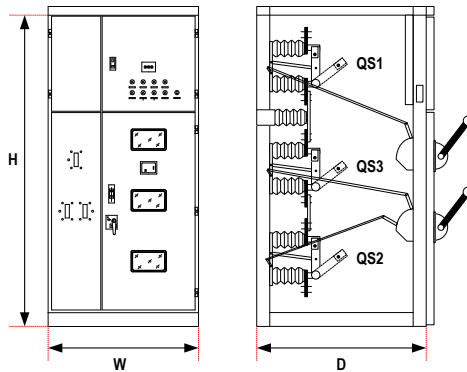


Table 2-1 Selection of the manual bypass cabinet

Power Range of Adaptable Motor (kW)	Output Capacity Range (kVA)	Adaptable Manual Bypass Cabinet Model	Manual Bypass Cabinet Dimensions (W x D x H: mm)
Voltage: 10 kV			
200–400	250–500	XGN28-12a-G13.G23.G33-A	1100 x 1150 x 2283
450–800	560–1000	XGN28-12a-G13.G23.G33-B	1100 x 1350 x 2283
900–1800	1120–2250	XGN28-12a-G14.G24.G34-C	1100 x 1250 x 2283
2000–3550	2250–4500	XGN28-12a-G15.G25.G35-D	1100 x 1396 x 2453
4000–5000	4500–6300	XGN28-12a-G15.G25.G35-E	1100 x 1498 x 2453

Note

The data in Table 2-1 is only applicable for the 10 kV voltage class and the dimensions is for reference only. For other information, contact Inovance.

The main circuit diagram of the manual bypass cabinet is shown in the following figure.

Figure 2-6 Main circuit diagram of the manual bypass cabinet



Note

QS1, QS2 and QS3 are isolation knife switches. QF is the user MV switch cabinet.

2. Automatic bypass cabinet

There are three contactors (KM1, KM2 and KM3) inside the automatic bypass cabinet to implement automatic switchover through electrical control circuit.

The physical appearance and overall dimensions of the automatic bypass cabinet are shown in the following figure:

Figure 2-7 Physical appearance and overall dimensions of the automatic bypass cabinet

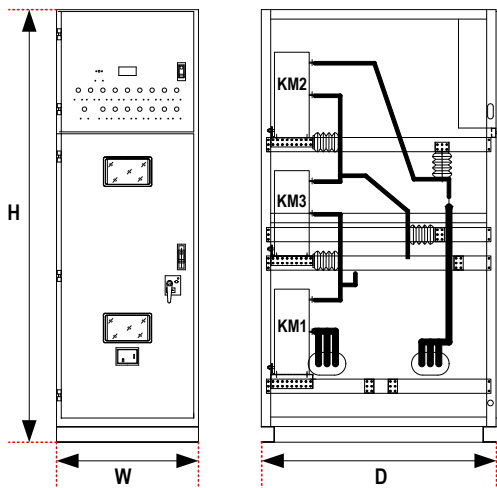


Table 2-2 Selection of the automatic bypass cabinet

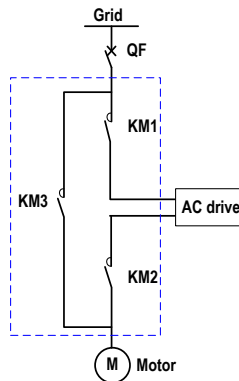
Power Range of Adaptable Motor (kW)	Output Capacity Range (kVA)	Automatic Bypass Cabinet Model	Automatic Bypass Cabinet Dimensions (W x D x H: mm)
Voltage: 10 kV			
200–400	250–500	#	750 x 1150 x 2283
450–800	560–1000	#	750 x 1350 x 2283
900–1800	1120–2250	#	750 x 1250 x 2283
2000–3550	2250–4500	#	750 x 1396 x 2453
4000–5000	4500–6300	#	750 x 1498 x 2453

Note

- The data in Table 2-2 is only applicable for the 10 kV voltage class and the dimensions is for reference only. For other information, contact Inovance.
- “#” indicates that the model is under development. For details, contact Inovance.
- For consideration of safety, Inovance does not recommend the automatic bypass cabinet.

The main circuit diagram of the automatic bypass cabinet is shown in the following figure.

Figure 2-8 Main circuit diagram of the automatic bypass cabinet



Note

- If the output current of the AC drive is larger than 400 A, add a pre-charge cabinet to suppress the magnetizing inrush current at power-on of the transformer, minimize impact on the grid and reduce damage to capacitors of the power cells.
- Detailed scheme: Connect current-limiting resistor of proper resistance in series in the primary three phases of the transformer, add corresponding vacuum contactor in the resistor connected circuit, and meanwhile add the bypass vacuum contactor. When pre-charging starts, close the vacuum contactor in the resistor connected circuit. This moment the current-limiting resistor is input into the main circuit to suppress the magnetizing inrush current at power-on of the transformer. After pre-charging completes, the bypass vacuum contactor closes automatically, and the current-limiting resistor is bypassed in the main circuit. Then open the vacuum contactor in the resistor connected circuit. The whole AC drive power-on process is completed.
- For other information about the pre-charge cabinet, contact Inovance.

2.3 Technical Specifications

Table 2-3 Technical specification

Voltage	3 kV Series	6 kV Series	10 kV Series
Input			
Rated input voltage	Three-phase 3 kV	Three-phase 6 kV	Three-phase 10 kV
Input voltage range	3 kV/6 kV/10 kV±10%: full-load running -10% to -35%: long-time de-rating running allowed		
Rated input frequency	50/60 Hz		
Cell input voltage	690 V		
Input power factor	≥ 0.95 (20% to 100% of load)		
Input current harmonics	Complying with the IEEE519-1992 and GBT14549-93 standards		
Output			
Output voltage range	0 to 3 kV	0 to 6 kV	0 to 10 kV
Output capacity range [1]	230 to 3700 kVA	230 to 10000 kVA	250 to 12500 kVA
Output frequency range [2]	0 to 50/60 Hz Maximum 120 Hz (120 to 700 Hz can be customized)		
Control mode	SVC1, CLVC, SVC2		
Speed range	40:1 (SVC2) 100:1 (SVC) 1000:1 (CLVC)		
Speed accuracy	±0.5% (SVC) ± 0.02% (CLVC)		
Acceleration/Deceleration time	0.1s to 6500.0s		
Start/Stop control	Local/Remote		
Control system	ARM, DSP, FPGA, CPLD, HMI		
Display	Touch screen, simplified Chinese/English		
Overload capacity	One minute for 120% of rated current		
Equipment efficiency	≥ 96%		
Protections	Motor overload, output overload, output short circuit, output grounded, output overcurrent, input overvoltage, cooling fan faulty alarm, door switch interlock, transformer overtemperature alarm, transformer overtemperature trip		
Mean time between failures (MTBF)	50000 h		
Communication interfaces	CAN, Modbus-RTU, Profibus-DP (optional)		
DI	10 channels, relay dry contacts		
DO	16 channels, relay dry contacts		
AI	4 channels, 4–20 mA		

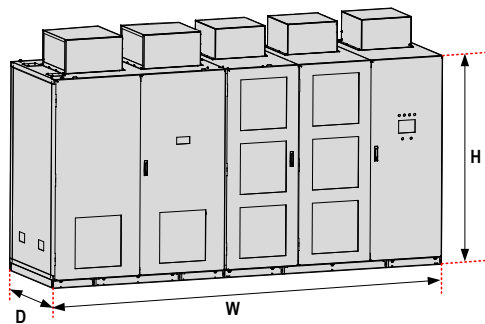
Voltage	3 kV Series	6 kV Series	10 kV Series
AO	5 channels, 4–20 mA		
Working environment	Indoors		
Ambient temperature	-10°C to 40°C (de-rated when above 40°C, preheated when below 0°C)		
Humidity	5% to 95%, no condensation		
Altitude	≤ 1000 m (de-rated when above 1000 m) Specify it in your order.		
Total equipment noise	≤ 75 dB		
Cooling mode	Add air conditioner or use the air-water cooling device		
IP level	IP30		
Inlet and outlet mode [3]	Down inlet and down outlet		
Control power	380 VAC±10%, three-phase four-wire		
Encoder type [4]	15 VDC OC encoder and 5 VDC differential encoder		

Note

[1 to 4]: Contact Inovance if you have special requirements.

2.4 Physical Appearance and Overall Dimensions of the HD9X

Figure 2-9 Physical appearance of the HD9X



The system overall dimensions, as listed in the following table, are for reference only and may slightly differ from the actual dimensions. For actual dimensions, contact the sales person of Inovance.

Table 2-4 Overall dimensions of the HD9X

HD9X Model	Adaptable Motor Power (kW)	Output Capacity (kVA)	Overall Dimensions (W x D x H: mm)
Voltage Class: 6 kV			
HD9X-F060/230	185	230	2870 x 1110 x 2285
HD9X-F060/250	200	250	2870 x 1110 x 2285
HD9X-F060/280	220	280	2870 x 1110 x 2285
HD9X-F060/315	250	315	2870 x 1110 x 2285
HD9X-F060/355	280	355	2870 x 1350 x 2285
HD9X-F060/400	315	400	2870 x 1350 x 2285
HD9X-F060/450	355	450	2870 x 1350 x 2285
HD9X-F060/500	400	500	2870 x 1350 x 2285
HD9X-F060/560	450	560	2870 x 1350 x 2285
HD9X-F060/630	500	630	2870 x 1350 x 2285
HD9X-F060/710	560	710	3650 x 1250 x 2285
HD9X-F060/800	630	800	3650 x 1250 x 2285
HD9X-F060/900	710	900	3650 x 1250 x 2285
HD9X-F060/1000	800	1000	3650 x 1250 x 2285
HD9X-F060/1120	900	1120	3650 x 1250 x 2285
HD9X-F060/1250	1000	1250	3650 x 1250 x 2285
HD9X-F060/1400	1120	1400	3650 x 1250 x 2285
HD9X-F060/1600	1250	1600	4950 x 1300 x 2455
HD9X-F060/1800	1400	1800	4950 x 1300 x 2455
HD9X-F060/2000	1600	2000	4950 x 1300 x 2455
HD9X-F060/2250	1800	2250	4950 x 1300 x 2455
HD9X-F060/2500	2000	2500	4950 x 1300 x 2455
HD9X-F060/2800	2240	2800	4950 x 1400 x 2455
HD9X-F060/3000	2400	3000	4950 x 1400 x 2455
HD9X-F060/3150	2500	3150	4950 x 1400 x 2455
HD9X-F060/3500	2800	3500	4950 x 1400 x 2455
HD9X-F060/4000	3150	4000	8000 x 1450 x 2600
HD9X-F060/4500	3550	4500	8000 x 1450 x 2600
HD9X-F060/5000	4000	5000	8000 x 1450 x 2600
HD9X-F060/5600	4500	5600	8000 x 1450 x 2600
HD9X-F060/6300	5000	6300	8000 x 1450 x 2600
HD9X-F060/7000	5600	7000	8200 x 1600 x 2600
HD9X-F060/8000	6300	8000	8200 x 1600 x 2600

HD9X Model	Adaptable Motor Power (kW)	Output Capacity (kVA)	Overall Dimensions (W x D x H: mm)
HD9X-F060/9000	7100	9000	8200 x 1600 x 2600
HD9X-F060/10000	8000	10000	8200 x 1600 x 2600
Voltage Class: 10 kV			
HD9X-J100/250	200	250	3200 x 1110 x 2285
HD9X-J100/280	220	280	3200 x 1110 x 2285
HD9X-J100/315	250	315	3200 x 1110 x 2285
HD9X-J100/355	280	355	3200 x 1110 x 2285
HD9X-J100/400	315	400	3200 x 1110 x 2285
HD9X-J100/450	355	450	3200 x 1110 x 2285
HD9X-J100/500	400	500	3200 x 1110 x 2285
HD9X-J100/560	450	560	3200 x 1110 x 2285
HD9X-J100/630	500	630	3200 x 1110 x 2285
HD9X-J100/710	560	710	3200 x 1110 x 2285
HD9X-J100/800	630	800	3450 x 1350 x 2285
HD9X-J100/900	710	900	3450 x 1350 x 2285
HD9X-J100/1000	800	1000	3450 x 1350 x 2285
HD9X-J100/1120	900	1120	4535 x 1250 x 2285
HD9X-J100/1250	1000	1250	4535 x 1250 x 2285
HD9X-J100/1400	1120	1400	4535 x 1250 x 2285
HD9X-J100/1600	1250	1600	4535 x 1250 x 2285
HD9X-J100/1800	1400	1800	4535 x 1250 x 2285
HD9X-J100/2000	1600	2000	4535 x 1250 x 2285
HD9X-J100/2250	1800	2250	4535 x 1250 x 2285
HD9X-J100/2500	2000	2500	6295 x 1400 x 2455
HD9X-J100/2800	2240	2800	6295 x 1400 x 2455
HD9X-J100/3000	2400	3000	6295 x 1400 x 2455
HD9X-J100/3150	2500	3150	6295 x 1400 x 2455
HD9X-J100/3500	2800	3500	6295 x 1400 x 2455
HD9X-J100/4000	3150	4000	6295 x 1400 x 2455
HD9X-J100/4500	3550	4500	6295 x 1400 x 2455
HD9X-J100/5000	4000	5000	6295 x 1500 x 2455
HD9X-J100/5600	4500	5600	6295 x 1500 x 2455
HD9X-J100/6300	5000	6300	6295 x 1500 x 2455
HD9X-J100/7000	5600	7000	10300 x 1650 x 2600
HD9X-J100/8000	6300	8000	10300 x 1650 x 2600
HD9X-J100/9000	7100	9000	10300 x 1650 x 2600

HD9X Model	Adaptable Motor Power (kW)	Output Capacity (kVA)	Overall Dimensions (W x D x H: mm)
HD9X-J100/10000	8000	10000	10500 x 1750 x 2750
HD9X-J100/11250	9000	11250	10500 x 1750 x 2750
HD9X-J100/12500	10000	12500	13700 x 1600 x 2600 (two transformers)

Note

- The overall dimensions do not include the height of the cooling fan. To install the cooling fan, an extra of 600 mm is required.
 - The overall dimensions are for reference only. The actual dimensions are determined by your order.
 - If the capacity is ≥ 4000 kVA at 6 kV power class or is ≥ 7000 kVA at 10 kV power class, the overall cabinet width includes the width of the pre-charge cabinet.
 - The overall dimensions are suitable for the standard products of 6 kV and 10 kV only. Contact Inovance if the capacity is ≥ 4000 kVA at 6 kV power class or is ≥ 7000 kVA at 10 kV power class, or you have customized requirements.
-



Mechanical and Electrical Installation

Chapter 3 Mechanical and Electrical Installation

Install the HD9X AC drive in proper position and refer to the foundation diagram that is delivered together with the equipment for workshop arrangement and construction.

3.1 Installation Requirements

3.1.1 Installation Environment Requirements

Item	Requirements																
Ambient temperature	-10°C to 40°C Preheated when below 0°C, and de-rated when above 40°C The average temperature for 24 hours must be in the range of 5 to 35°C.																
Relative humidity	Below 50% at 40°C 85% or less at low temperature No condensation due to temperature change																
Altitude	Below 1000 m De-rated when above 1000 m Notify Inovance in advance if the altitude is above 1000 m.																
Air pressure	860 to 1060 kPa																
Air quality	The dust in the electrical room must be equal to atmospheric dust and must not contain ferrous powder or organic silicon particles.																
Corrosion factors	<table border="1"> <thead> <tr> <th>Corrosive Gases</th> <th>Concentration</th> </tr> </thead> <tbody> <tr> <td>Hydrogen sulfide (H2S)</td> <td>≤ 0.001 PPM</td> </tr> <tr> <td>Sulfur dioxide (SO2)</td> <td>≤ 0.05 PPM</td> </tr> <tr> <td>Chlorine (Cl2)</td> <td>≤ 0.1 PPM</td> </tr> <tr> <td>Ammonia (NH3)</td> <td>≤ 0.1 PPM</td> </tr> <tr> <td>Nitrogen oxide (NOx)</td> <td>≤ 0.02 PPM</td> </tr> <tr> <td>Ozone (O3)</td> <td>≤ 0.002 PPM</td> </tr> <tr> <td>Hydrogen chloride (HCl)</td> <td>≤ 0.1 mg/m³</td> </tr> </tbody> </table>	Corrosive Gases	Concentration	Hydrogen sulfide (H2S)	≤ 0.001 PPM	Sulfur dioxide (SO2)	≤ 0.05 PPM	Chlorine (Cl2)	≤ 0.1 PPM	Ammonia (NH3)	≤ 0.1 PPM	Nitrogen oxide (NOx)	≤ 0.02 PPM	Ozone (O3)	≤ 0.002 PPM	Hydrogen chloride (HCl)	≤ 0.1 mg/m ³
	Corrosive Gases	Concentration															
	Hydrogen sulfide (H2S)	≤ 0.001 PPM															
	Sulfur dioxide (SO2)	≤ 0.05 PPM															
	Chlorine (Cl2)	≤ 0.1 PPM															
	Ammonia (NH3)	≤ 0.1 PPM															
	Nitrogen oxide (NOx)	≤ 0.02 PPM															
Ozone (O3)	≤ 0.002 PPM																
Hydrogen chloride (HCl)	≤ 0.1 mg/m ³																

Note

The preceding table gives the standard specifications. For details, see the Technical Protocol.

⚠ DANGER

- Never use silicon series paraffin for the electrical room floor. Failure to comply will have bad impact on electrical contacts.
- After connecting external cables (ground cables, main circuit cables and control cables) into the cabinet, seal the cable entry hole with the putty. Otherwise, small animals such as rats may gain access to the cabinets and this may cause serious damage to the equipment

3.1.2 Storage Environment Requirements

Item	Specification
Storage temperature	-20°C to 50°C Temperature change less than 1°C/min
Relative humidity	5% to 95%
Storage environment	Free from direct sunlight, dust, corrosive gases, inflammable gases, oil mist, vapor and water drop

Note

- Improper storage will influence the serving life of the AC drive and may even cause the AC drive not to be used normally.
- For the reference of storage environment, refer to the standards IEC61800-4(GB12668.4-2006), UDC 621.3:658.78 and GB4798.1-88.

■ General Requirements

- Never directly place the AC drive on the floor but place it on a pallet.
- Add appropriate amount of desiccant if it is moist.
- Use polyethylene sheet or aluminum foil as protective packing to avoid water seepage.

■ Periodical Inspections

- Check the conditions of storage and packing of the AC drive every month during the whole storage period. Pay special attentions to damages caused by mechanical forces, humidity, temperature or fire.
- If the packing is damaged or you find any damage on the AC drive, check the damage immediately. After the damaged AC drive is repaired, store it as described above.

■ Storage of Spare Parts

- The spare parts must be stored in the position free from vibration and shock and be protected against moisture, frost, temperature change, dust and gravel.
- The spare parts must be stored in their original packing in a dry and insect-proof room. The storage place must be free of corrosive gases.
- Relative humidity: 5% to 95%

If you find the maximum allowed humidity is allowed, protect the spare parts by taking proper measures such as reducing temperature, heating and dehumidifying.

- The spare parts must be stored in the temperature of -20°C to 50°C.
- The electronic boards must be stored in the antistatic bag that prevents desiccant leakage and free from corrosive gases or gases containing salt, soda or other impurities. No water condensation is allowed.
- Power cells have built-in electrolytic capacitor. Long-term storage will degrade the electrolytic capacitor. Thus, the power cells must be energized once every six months.

3.1.3 Installation Clearance Requirements

For the cabinet size and installation of the HD9X, refer to the related drawings of the delivered technical materials. Install all cabinets according to the drawings.

- Maintain sufficient clearances around the HD9X series AC drive for proper ventilation, maximum door swing and maintenance.
- Provide a passage for access to the installation foundation and ensure sufficient space of the auxiliary equipment that is used to transport the AC drive.

Figure 3-1 Clearance requirements

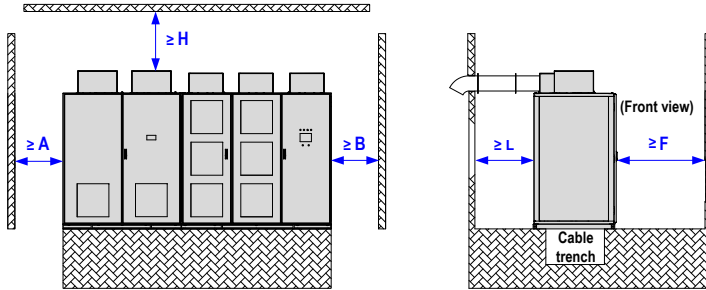


Table 3-1 Clearance requirements

HD9X Model	A	B	F	L	H
HD9X-J100/250	800	800	1500	1000	1000
HD9X-J100/280	800	800	1500	1000	1000
HD9X-J100/315	800	800	1500	1000	1000
HD9X-J100/355	800	800	1500	1000	1000
HD9X-J100/400	800	800	1500	1000	1000
HD9X-J100/450	800	800	1500	1000	1000
HD9X-J100/500	800	800	1500	1000	1000
HD9X-J100/560	800	800	1500	1000	1000
HD9X-J100/630	800	800	1500	1000	1000
HD9X-J100/710	800	800	1500	1000	1000
HD9X-J100/800	800	800	1500	1000	1000
HD9X-J100/900	800	800	1500	1000	1000
HD9X-J100/1000	800	800	1500	1000	1000
HD9X-J100/1120	800	800	1500	1000	1000
HD9X-J100/1250	800	800	1500	1000	1000
HD9X-J100/1400	800	800	1500	1000	1000
HD9X-J100/1600	800	800	1500	1000	1000
HD9X-J100/1800	800	800	1500	1000	1000

HD9X Model	A	B	F	L	H
HD9X-J100/2000	800	800	1500	1000	1000
HD9X-J100/2250	800	800	1500	1000	1000
HD9X-J100/2400	800	800	1500	1000	1000
HD9X-J100/2800	800	800	1500	1000	1000
HD9X-J100/3150	800	800	1500	1000	1000
HD9X-J100/3550	800	800	1500	1000	1000
HD9X-J100/4000	800	800	1500	1000	1000
HD9X-J100/4500	800	800	1500	1000	1000
HD9X-J100/5000	800	800	1500	1000	1000
HD9X-J100/5600	800	800	1500	1000	1000
HD9X-J100/6300	800	800	1500	1000	1000
HD9X-J100/7000	800	800	1800	1000	1000
HD9X-J100/8000	800	800	1800	1000	1000
HD9X-J100/9000	800	800	1800	1000	1000
HD9X-J100/10000	800	800	1800	1000	1000
HD9X-J100/11250	800	800	1800	1000	1000
HD9X-J100/12500	800	800	1800	1000	1000

Note

- The clearance requirements are applicable to the standard products of 10 kV only. For others, contact Inovance.
- Install all cabinets on the U-steel base solidly and tie them to the workshop ground reliably. The iron core of the transformer and the grounding terminal PE must also be connected to the workshop ground. All cabinets must be connected as a whole unit.
- The armor of MV inlet and outlet cables must be grounded reliably and fixed to the cabinets, must have sufficient mechanical strength, and keep proper grounding insulation distance as stipulated in all MV technical specifications.

3.1.3 Heat Dissipation

The HD9X series AC drive is large-sized electrical equipment and has very strict requirements on the environment. According to statistics on multiple equipments on site, the equipment is easy to get faulty because of too high ambient temperature. Thus, Inovance provides the following three heat dissipation solutions:

- Add an air conditioner.
- Add air duct.
- Use the air-water cooling system.

The three solutions are applicable to different situations. Select a proper solution according to the on-site environment.

■ Add an Air Conditioner

- Refrigerating capacity of air conditioner

Place an MV AC drive in an enclosed room and install an air conditioner in the room. The air conditioner dissipates the heat produced by the MV AC drive outside.

The total air conditioner capacity shall be MV AC drive heat output plus space refrigerating capacity required for the room.

$$Q_{\text{Air conditioner capacity}} = \{Q_{\text{AC drive heat output}}\} + \{Q_{\text{Space refrigerating capacity (ignored if below 40°C)}}\}$$

$$= (W_{\text{AC drive output power}} \times 3.5\%) + (S_{\text{Room area}} \times 0.15)$$

The heat produced by the MV AC drive must be estimated based on the actual operating condition. Considering certain margin, the maximum heat output is 4% of the rated power of MV AC drive.

Thus, the heat output of the MV AC drive is 3.5% of the actual output power on average. If the MV AC drive runs at below 40 Hz for long time, the heat output can be considered as 2% of the rated power.

The space refrigerating capacity is calculated based on the actual room area. Normally, 0.15 kW is required per square meter. Ignore this if the ambient temperature is below 40°C.

- Selection of air conditioner

1. Selection based on HP

$$X_{\text{Air conditioner HP}} = Q_{\text{Air conditioner capacity}} \div 2.5$$

2. Selection based on model

Normally, 1 HP is equal to 2500 W refrigerating capacity (model 25), and 1.5 HP is equal to 3500 W refrigerating capacity (model 35). You can estimate the horse power according to refrigerating capacity. For example, model 50 corresponds to 2 HP.

$$\nabla_{\text{Model}} = Q_{\text{Air conditioner capacity}} \div 100$$

3. Selection based on air conditioner power

$$W_{\text{Power}} = Q_{\text{Air conditioner capacity}} \div \eta_{\text{Energy efficiency ratio}}$$

$$\approx X_{\text{Air conditioner horse power}} \times 735 \text{ (unit: watt)}$$

4. Advantage of adding an air conditioner

Adding an air conditioner can keep the indoor environment clean, prolong the serving life of the MV AC drive and reduce the maintenance rate.

■ Add an Air Duct

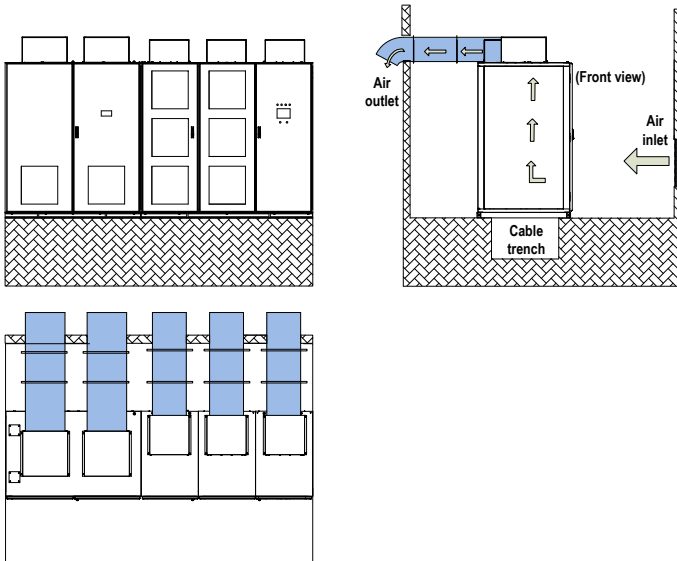
• Design of air duct

Generally, the air duct is designed above cabinet, which directly dissipates heat produced by the MV AC drive. Cold air is continuously supplied from the air inlet to cool the system.

Inovance provides the following two methods of installing the air duct.

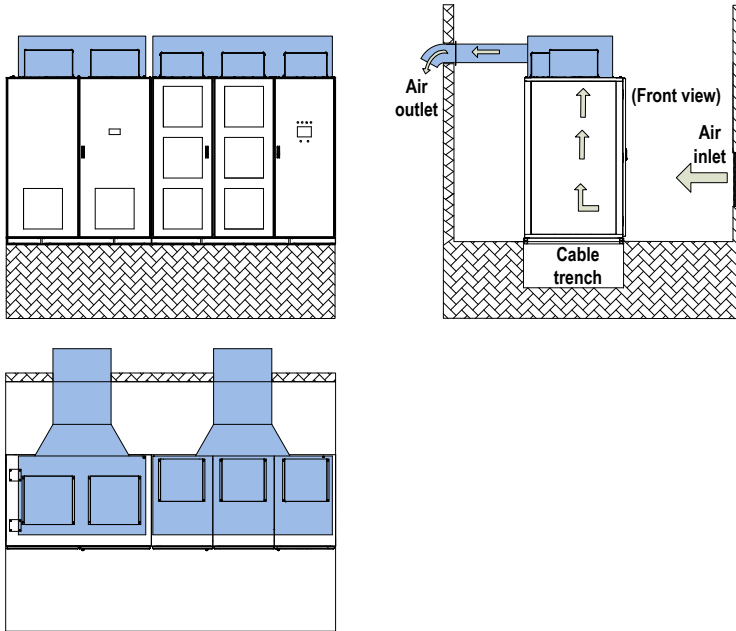
1. Connect air duct to the fan cover.

Figure 3-2 Connect the air duct to the fan cover



2. Add an air duct to the power cell cabinet and transformer cabinet separately.

Figure 3-3 Add air duct to the power cell cabinet and transformer cabinet



- Advantage of adding an air duct

The air duct is cost effective, highly reliable and well ventilated. It is applied to clean environment.

Note

- If the cooling fan on the top of the cabinet is near the air outlet (less than 2 m, no turning in air duct), it is unnecessary to install an auxiliary exhaust fan at the air outlet. Otherwise, install an auxiliary exhaust fan there. If on-site construction is inconvenient at the air inlet and the air duct requires turning, consider installing a fan to force air inlet.
- If the air duct is designed improperly, rainwater may flow backward on rainy days, which will result in short-circuit to the MV AC drive. The whole ventilation pipe must have certain inclination angle. Cut a hole at downside of the pipe for ventilation to avoid rainwater flowing backward. You also need to add an air filter to the hole to prevent access of small animals.
- Make the air duct according to related air duct design drawing delivered together with the equipment. Determine whether to remove the side panels of the fan cover based on the actual air duct design.

■ Use the Air-Water Cooling System

• Air-Water Cooling Principle

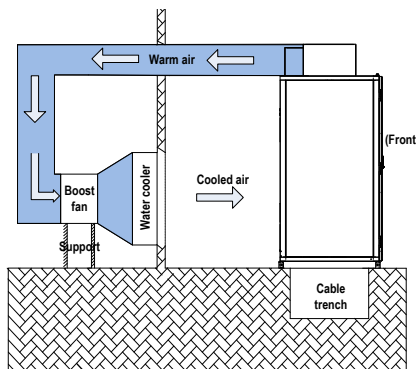
The warm air produced by the AC drive runs through the air duct and enters the air-water cooling device, which then performs heat transfer and takes away the heat by the cooling water. Finally, the cooled air is directly feed indoors.

The temperature of the cooling water must be below 33°C, which ensures the indoors ambient temperature of the AC drive below 40°C when the warm air passes the heatsink.

The cooling water is completely separated from the re-circulating air. The water pipeline is outside the AC drive room, protecting the AC drive from security threat and accident such as waterproof damage or insulation damage.

This cooling method has the advantages of low degree of dust and less maintenance work and reduces the negative effect of stability of power cell cabinet and control cabinet.

Figure 3-4 Air-water cooling system structure



• Air-water cooling conditions

1. The on-site provided industrial cooling water temperature must be equal to or below 33°C. The air injection pressure must be between 0.25 MPa and 0.55 MPa. The water backflow pressure drop must be equal to or below 0.1 MPa.
2. The necessary amount of cooling water can be provided on site. You can obtain the necessary amount of cooling water from the formula: Heating power (kW) : Cooling water flow (m³/h) = 4 : 1 (single air-water cooling system).
3. Prepare an enclosed room with 10 cm above insulating layer or thermal insulation measure for the AC drive.
4. The net height of the enclosed room must be equal to or greater than 3.5 m. The length of the construction site must be two times of the room length in the room length direction and its width must be 2.0 m at least.
5. Two-circuit 380 VAC/3 PH power supplies must be provided on site. The AC drive room requires the power capacity of 6 kW.
6. The cooling water must have no deposition accumulations and the PH value must be equal to or greater than 7.2.

- Selection Principle

Take the 4000 kW load as an example:

If the rated power is 4000 kW and the running efficiency is 96%, the maximum heating power of the AC drive is $4000 \times 4\% = 160$ kW.

The system implements heat transfer of the warm air exhausted by the AC drive through the air-water cooling device and then feeds the cooled air back to the room. This reaches the air cycle efficiency of close to 99%.

Considering the heat dissipation of ultimate running, higher water temperature and heat transfer efficiency, we generally select a 1.15 to 1.2 times margin for the air-water cooling device. That is, the heat transfer power of single air-water cooling device must be equal to or greater than 184 kW. Then we need select the air-water cooling device with cooling power of 190 to 200 kW.

Total cooled air volume of the AC drive is obtained from: Air volume of single fan x Number of fans. The fans on the AC drive cabinet top and the fan of the air-water cooling device are in the hot standby structure.

The system adopts indoors enclosed circulating cooling method to keep the ambient temperature below 40°C. When the air-water cooling device is faulty or the outdoor temperature is low, separate the air exhaust outlet of the AC drive from the air inlet of the air-water cooling device. The warm air produced by the AC drive is directly exhausted outside. This can reduce the AC drive running costs.

The on-site cooled water flow can be estimated according to 3 to 4 m³/h required every 10 kW cooling power.

3.1.4 Foundation Design

The HD9X must be installed on the concrete non-flammable floor. Ensure that the floor is level with surface irregularity of less than 5 mm, moisture-proof, smooth with no wear, and able to bear the weight of the MV AC drive.

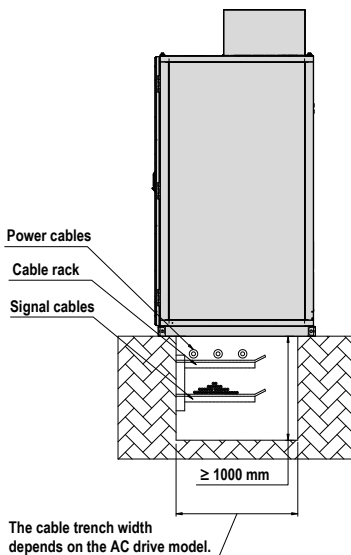
The cable ducts must use non-flammable materials and has no wear on surface. Moisture-proof, dustproof and rat-proof measures are required.

The foundation construction must be done according to related foundation diagram provided by Inovance.

In the design of the foundation, take the following items into consideration:

- Adequate space for inspection and maintenance in the front and back of the MV AC drive
- Position of air duct
- Cabling of power cables, MV motor cable, and system control cables
- Design the cable trench or cable channel below the MV AC drive. The MV cables, power cables and signal cables must be separated.
- The cable arrangement is shown in the following figure. For detailed dimensions, see the product brochure delivered together with the equipment.

Figure 3-5 Cable arrangement



WARNING

- Strictly separate MV cables and low-voltage cables.
- The cable trench must use non-flammable materials and be smooth. Moisture-proof, dust-proof and rat-proof measures are required.

■ Cable Requirements

1. Power cables

- Arrangement of main power cables and motor cables must comply with local codes and refer to descriptions of cable manufacturers.
- To ensure compliance with the EMC requirements, it is recommended that a steel armored three-phase cable with each phase individually shielded be used. If single-phase cables are used, the cables of three different phases must be grouped together.
- If the cross-sectional area of the cable shield is smaller than 50% of the sectional area of one phase, lay an additional grounding cable along the power cable to avoid overtemperature of the cable shield. For details, query local codes.
- Reserve adequate distance between cable racks, ladders or trays inside the cable trench so that it is convenient to lay cables and connect connectors, and convenient to replace or add a cable and its connector when multiple cables are laid on the same rack, ladder or tray.
- The distance between cable racks, ladders or trays must be greater than 300 mm; the minimum clear distance from the bottom rack to the trench bottom must be greater than 100 mm.
- The cables are fixed with cable racks. For horizontal cabling, if outside diameter of power cables and control cables is 50 mm or smaller, set a rack every 0.6 m. If the outside diameter of power cables is larger than 50 mm, set a rack every 1.0 m. The single-phase cables that form a regular triangle must be tied up with a strap every 1.0 m. For vertical cabling, set a rack every 1.0–1.5 m.
- Lay power cables and control cables separately on racks on different sides of the trench with a vertical distance of larger than 300 mm. If the requirement is not satisfied, set power cables on the rack above control cables.

2. Ground cables

Laying of ground cables must comply with local codes.

3. Control cables

Do not lay control cables in parallel to power cables. If parallel cabling cannot be avoided, a minimum vertical distance of 300 mm (12 inch) must be maintained between control cables and power cables. In addition, control cables and power cables must be crossed at an angle of 90°.

Note

The power cables must be terminated with connectors according to the cable manufacturer's requirements. Power connectors must be made by authorized personnel.

3.2 Mechanical Installation

3.2.1 Packing

Invoice determines crate packing or simple packing according to logistics difficulty and client agreement.

- Crate packing: The whole product is packed in the crate.
- Simple packing: The product has the pallet at the bottom and takes simple waterproof and dustproof measures such as plastic film on the other parts.

No matter which packing method is selected, the equipment security during transportation can be ensured. If you have special packing requirement, negotiate with Inovance before placing an order.

Figure 3-6 Crate packing

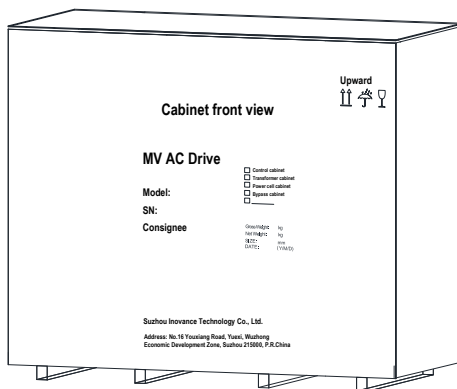
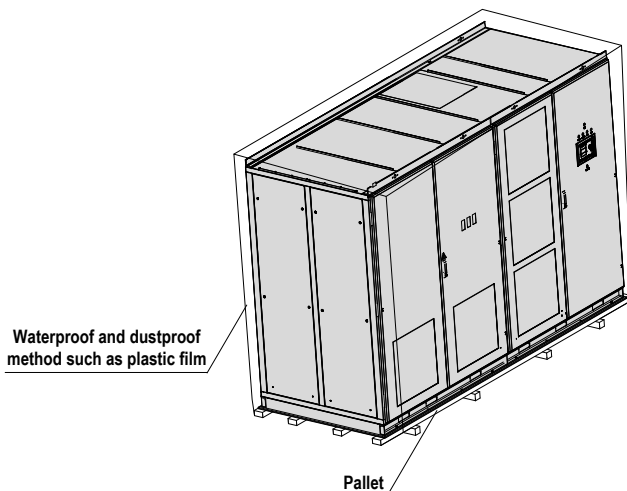


Figure 3-7 Simple packing



3.2.2 Transportation

The HD9X can be transported by road, rail and ship. Observe the following precautions during transportation:

- Hand it with care to prevent damage.
- Never expose it to sunlight and rain.
- Never shake or strike the AC drive, or transport it with upside down.
- Keep the temperature within the range of -40°C to 70°C.
- The AC drive is 2600 mm high (fan not included). Total height after packaging must not exceed 3000 mm. Take the height limit into consideration when selecting the transportation vehicle.

⚠ DANGER

Never transport the AC drive with lifting eyes on the top of the cabinet because these lifting eyes are designed to transport the empty cabinet and have no weight bearing capacity.

The HD9X of small power has been assembled, tested and packaged as a whole unit before delivery. The other models require on-site assembling of the transformer cabinet and power cell cabinet (control cabinet belongs to the power cell cabinet) that are transported independently.

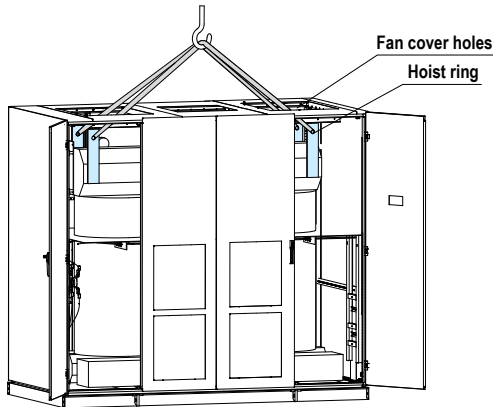
The HD9X can be transported by:

- Hoist
- Roll pallet truck
- Rollers

■ Transporting the HD9X By Hoist

For large-capacity transformer cabinet, run the strap through the fan cover holes but do not touch the roof. Then hook the hoist rings and hoist the cabinet.

Figure 3-8 Hoisting large-capacity transformer cabinet



The assembled cabinet and independently transported power cabinet and transformer cabinet have a design of openings on the base for the use of hoist apparatus.

Install the four shackles respectively across the four openings on the base, and then run the strap (never use steel rope) through the shackles, and then place the straps onto the brackets that are fixed on the cabinet roof to isolate the strap and the cabinet contact parts. The small-capacity cabinets do not have such bracket, as shown in Figure 3-9.

Finally, lift the AC drive by hoist. After the hoisting is completed, remove the brackets and tighten the screws in situ, as shown in Figure 3-10.

Figure 3-9 Without protective brackets on the cabinet roof

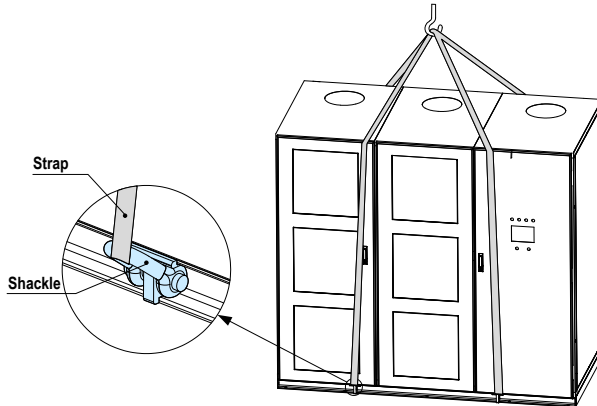
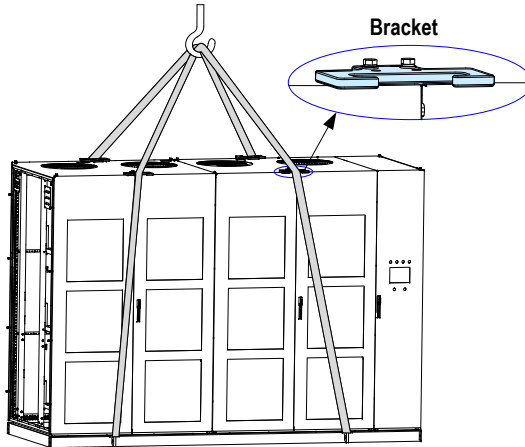


Figure 3-10 With protective brackets on the cabinet roof



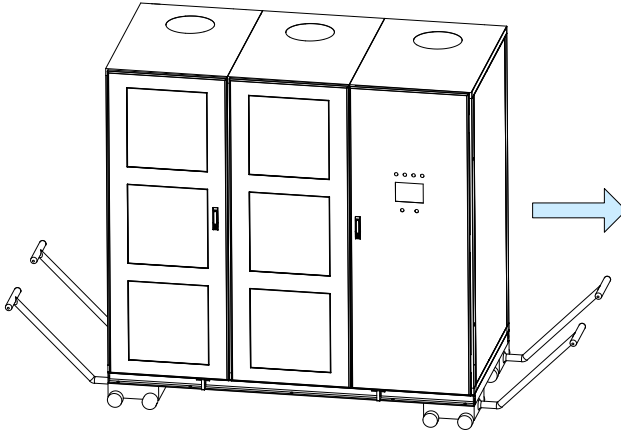
Note

Whether to use the protective bracket is determined by the actual cabinet structure and the hoisting label.

■ Transporting the HD9X by Roll Pallet Truck

When the HD9X is transported by roll pallet truck, the roll pallet truck must be placed under the four corners of the cabinet base, as shown in the following figure.

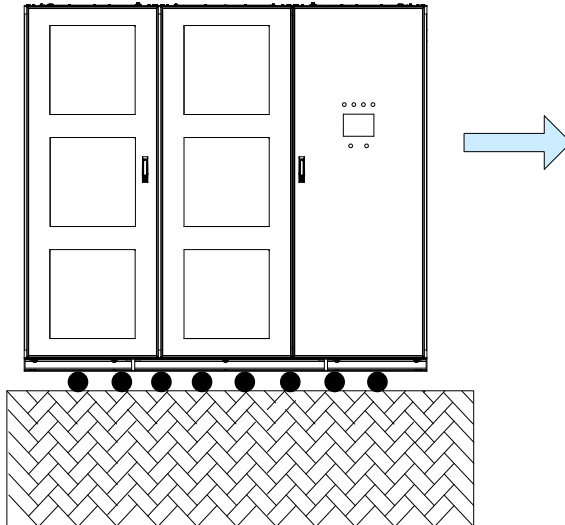
Figure 3-11 Transporting the HD9X by roll pallet truck



■ Transporting the HD9X by Rollers

When using rollers to transport the AC drive, put multiple rollers side by side on floor and move the cabinet on the rollers. Then run the rollers circularly to transport the AC drive, as shown in the following figure.

Figure 3-12 Transporting the HD9X by rollers



3.2.3 Unpacking

After receiving the HD9X AC drive, check whether any spare part is damaged. If yes, contact Inovance immediately. Inovance will assume no responsibility for any damage caused by external forces or external environment in the warranty period.

■ Before Unpacking

Checking Items

- Check whether the packing is intact and whether there is severe mechanical damage, collision, dust, water stain, mould, deformation and corrosion.
- Check whether the product SN is consistent with your order.
- Check whether the number of packing materials is consistent with the packing list.

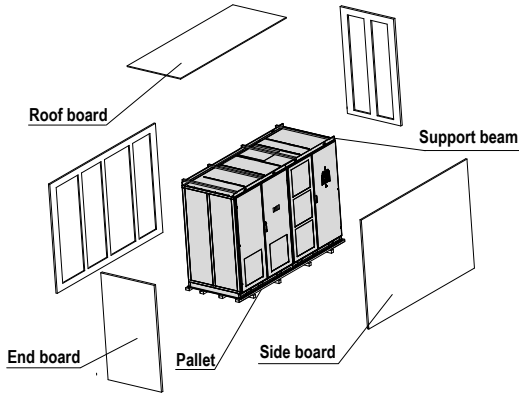
Note

If the equipment is damaged during transportation, take photos of the damaged part and fill in the transportation damage report. Then mail the report together with the photos to Inovance or the transportation company.

■ Unpacking the Crate

Steps	Operations
1	Place the crate in the workshop that is empty and flat, and prepare the tools such as crow bar and iron rod.
2	Use the crow bar to pry off the crate along the gap from the board edge. Then remove the roof board, side boards, ends boards and pallet. In the process, put the crow bar into the crate as short as possible so as to prevent damaging the equipment. Pry off the crate with care and protect you from being injured by nails.
3	Remove the inner packing materials such as plastic film. Remember not to use sharp tool to avoid scratching the equipment.
4	Remove the screws that connect the equipment and the pallet.

Figure 3-13 Unpacking the crate



Note

- When unpacking the crate, remove the roof board, support beams, side boards, end boards and the pallet in turn.
- Keep a minimum clearance of 20 mm between the equipment and the crate.

■ Unpacking the Simply Packed Equipment

Steps	Operations
1	Place the equipment in the workshop that is empty and flat, and remove the plastic film. Remember not to use sharp tool to avoid scratching the equipment.
2	Remove the screws that connect the equipment and the pallet.

■ Checking after Unpacking

Checking Items
<ul style="list-style-type: none"> • Open the back panel of the inverter part and check the internal condition. • Check the equipment related conditions (for example, transformer and motor) according to the related user guide. • Compare the equipment with your order to avoid missing any spare part. If any part is missed, immediately contact Inovance or the transportation company.

Precautions
<ul style="list-style-type: none"> • Check whether painting off and deformation occurs on the door and side panels. • Check whether the control cables become loose. • Check whether the spare parts that have not been assembled are intact. • Check whether the screws are tightened tightly. • Check whether any spare part is damaged. • Check the dust-proof layer. • Check whether any water stain exists. • Check whether any damage caused by worm and ants exists.

3.2.4 Moving the HD9X to Mounting Site and Fastening

The mounting instructions in this section apply to normal mounting conditions in the industrial environment. To mount the AC drive in special scenarios, contact Inovance in advance for detailed installation procedure.

1. Before performing mechanical installation, make sure that all preceding environment requirements described are satisfied.
2. Check the floor levelness with a spirit level. The maximum allowable overall unevenness is less than 5 mm. If the floor is uneven, make it leveled.
3. Open all cabinet doors and check whether the AC drive and attached components are damaged during transportation. If you find any defective or missing component, contact Inovance and the transportation company.

Open the cabinet doors in the method shown in the following figure.

Figure 3-14 Opening the front cabinet doors

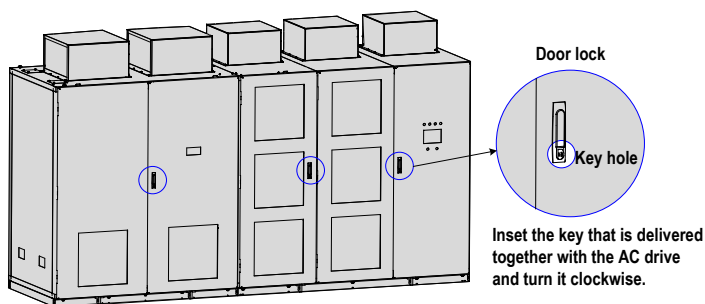
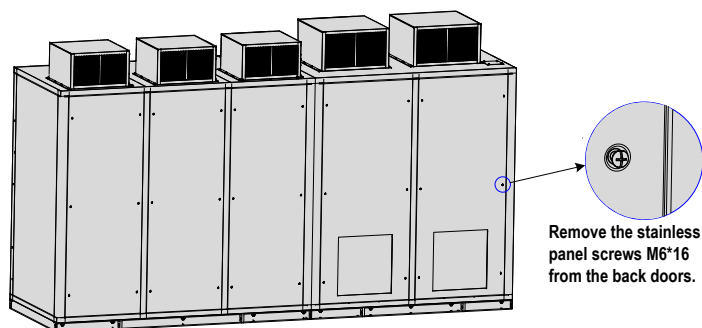
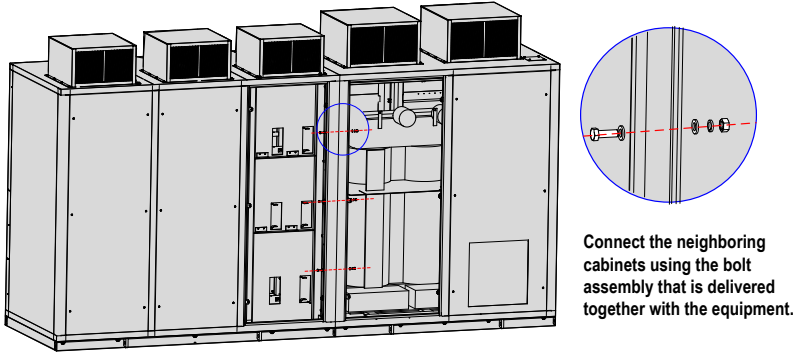


Figure 3-15 Opening the back cabinet doors



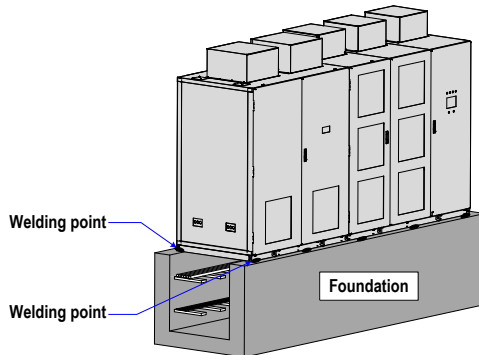
4. Check whether cabinet doors can be opened and closed completely. If not, adjust the cabinet body. Check the door limit lock. After power-on, all front and back doors, except the doors of the main control cabinet, cannot be opened. If the cabinet doors are opened without permission, the system will report a fault and enable the input MV breaker.
5. Adjust slightly the cabinets and fasten adjacent cabinets with screws, as shown in the following figure.

Figure 3-16 Fastening adjacent cabinets with screws



6. After assembling, fastening and leveling the cabinets, weld the cabinets to the U-steel on the foundation. Cable connection inside cabinets and between cabinets must be performed under the guidance of professionals of Inovance.

Figure 3-17 Welding assembled cabinets to the U-steel on the foundation



On some conditions, the phase-shifting transformer and power cells are individually packed for transportation. After arriving at the mounting site, the transformer and power cells shall be installed into their cabinets under the guidance of Inovance engineers.

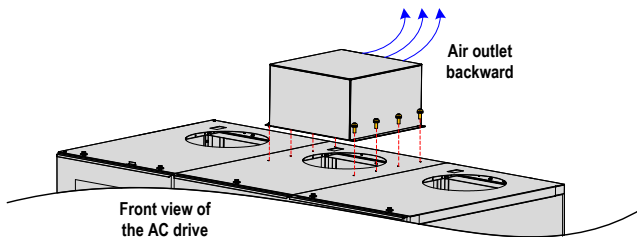
WARNING

Open the cabinet doors properly and never open the door with force. Failure to comply will result in damage to the AC drive.

3.2.5 Installing the Fan on the Cabinet Roof

The number of fans installed on the roof of the HD9X varies with the cabinet type. During installation, tighten the total of eight screws (M6*16) on both left and right sides of the fan, as shown in the following figure.

Figure 3-18 Installation of the fan on the cabinet roof



3.3 Electrical Installation

3.3.1 Precautions on Electrical Installation

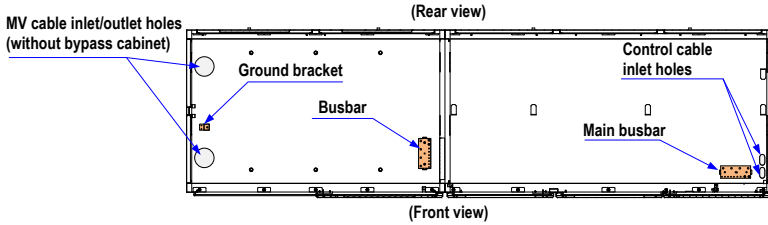
1. Ensure that the diameter and withstand voltage of the MV inlet cables and control power cables meet the requirements. The input and output MV cables must pass the withstand voltage test.
2. Ensure that the effective lightning-proof measure has been taken on the MV switch on the input side.
3. The armor of MV inlet cables and motor cables must be grounded reliably, be fixed into cabinets reliably, have sufficient mechanical strength, and keep proper insulation distance as stipulated in all MV technical specifications.
4. Wire the input and output cables separately to avoid cable mixing and danger caused by insulation damage.
5. Separate signal cables from power cables. Use shielded twisted-pair (STP) cables as analog signal cables and ensure that the shield is reliably grounded at one end.
6. Always keep the AC drive cabinet be grounded to workshop reliably to ensure personal safety.
7. Set a special grounding rod in the control cabinet before electrical installation and ensure its ground resistance is $2\ \Omega$ or less.
8. Before measuring insulation resistance of the transformer or performing the withstand voltage test, short all terminals on the secondary side of the transformer. Otherwise, power cells will be damaged. The test on the transformer must be agreed and supported by the manufacturer.

3.3.2 Cable Inlet/Outlet Holes

Precautions on cable inlet/outlet are as follows:

- Confirm the inlet/outlet holes of all cables.
- Make sure to strictly separate power cables from control cables.

Figure 3-19 Positions of cable inlet/outlet holes of the whole unit

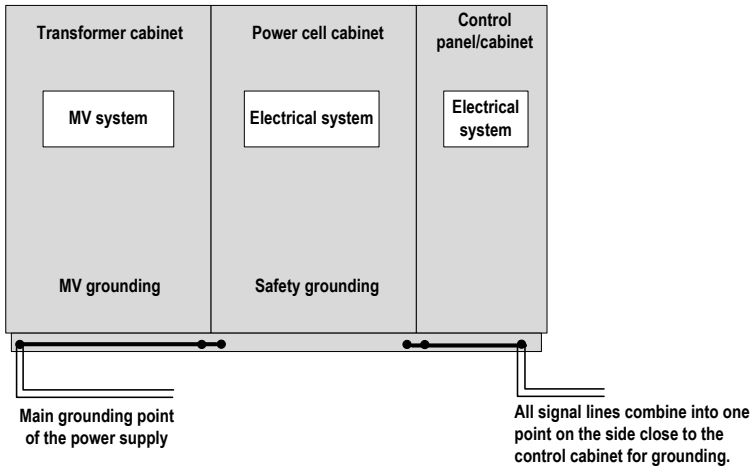


3.3.3 Grounding the HD9X

Ensure that the ground resistance is smaller than 4Ω and use a busbar of 25 x 4 mm for grounding.

Install the busbar in the cable trench under the foundation U-steel frame. Directly connect the main ground point of the MV system to the busbar tightly and then connect the busbar to the base of all cabinets. Combine all signal cables into one ground point and connect the point to the busbar, as shown in the following figure.

Figure 3-20 Grounding the HD9X



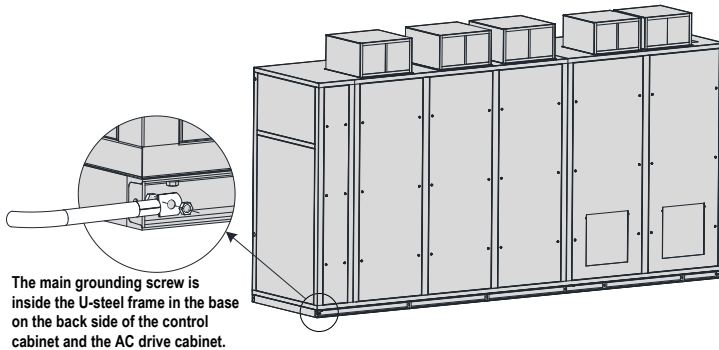
3.3.4 Connecting the Main Grounding Screw

The precautions on connecting the main grounding screw are as follows:

- Measure the resistance of the ground cable and the resistance must be smaller than 4 Ω .
- Mark the ground cable clearly.
- Ensure that the HD9X is in the de-energized state.

As shown in the following figure, connect the user main grounding cable or busbar to the main grounding screw of the AC drive. Then tighten the screw with torque of 45 N·m.

Figure 3-21 Wiring the main grounding screw



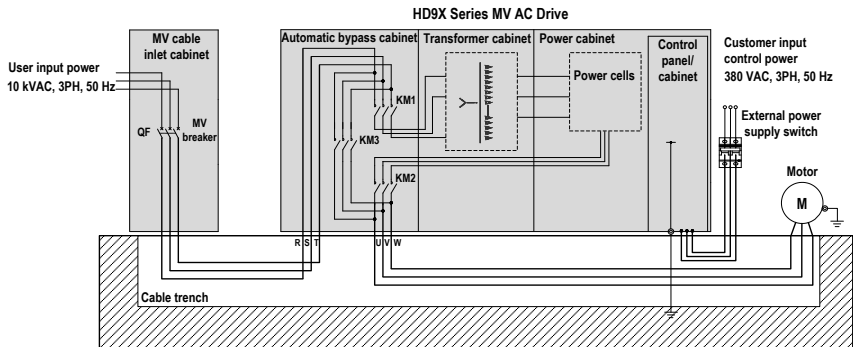
3.3.5 Wiring Main Circuits

Connect the inlet MV power cables to the input terminals, and motor cables to the output terminals of the AC drive. The MV power supply runs through the main circuit breaker and then to the HD9X drive. Only after receiving the MV switch-on allowed signal from the HD9X, the main circuit breaker can be closed.

The output terminals of the AC drive is connected to the motor directly (or through the bypass cabinet).

If an automatic bypass cabinet is used, the main circuits are wired according to the following figure.

Figure 3-22 Wiring main circuits with an automatic bypass cabinet

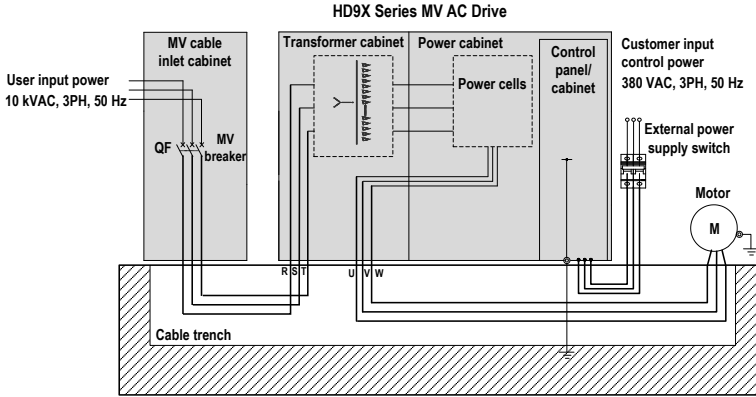


Note

- If a manual bypass cabinet is selected, only replace contactors KM1, KM2 and KM3 in Figure 3-22 with isolation switches QS1, QS2 and QS3, and the rest wiring is the same.
- Prepare cables for connection in Figure 3-22 by yourself. For selection and making of these cables, refer to the engineering drawing that is delivered together with the AC drive.

If the bypass cabinet is not used, the main circuits are as wired in the following figure.

Figure 3-23 Wiring main circuits without a bypass cabinet



Note

Prepare cables for connection in Figure 3-22 yourself. For selection and making of these cables, refer to the engineering drawing that is delivered together with the AC drive.

⚠ DANGER

Never wrongly connect the input and output terminals. Failure to comply will result in severe damage to the MV AC drive.

⚠ DANGER

- Ensure that the power supply has been cut off before wiring. Failure to comply will result in electric shock or a fire.
- Only allow authorized electrical engineer to perform wiring. Failure to comply may result in electric shock or a fire.
- Ensure reliable grounding of cabinets. Failure to comply may result in electric shock or a fire.
- Check that the emergency stop button is normal before power-on.
- Never touch output terminals directly, connect output terminals to the housing of the AC drive, or short output terminals. Failure to comply may result in electric shock or short circuit.

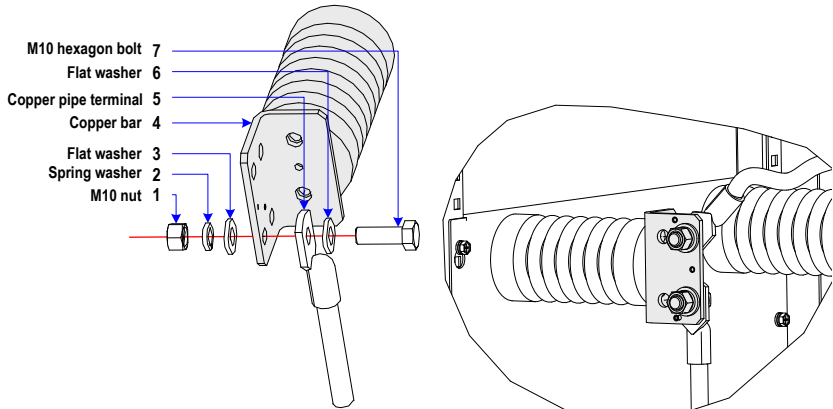
3.3.6 Connecting MV Inlet and Outlet Terminals

The precautions on connecting the MV inlet and outlet terminals are as follows:

- Check phases U, V, W and mark them clearly.
- Ensure that the HD9X is in the de-energized state.

As shown in the following figure, run the three-phase (U, V, W) cable into the corresponding cable holes and connect it to the corresponding three-phase busbar. Then tighten the M10 screw with torque of 45 N·m.

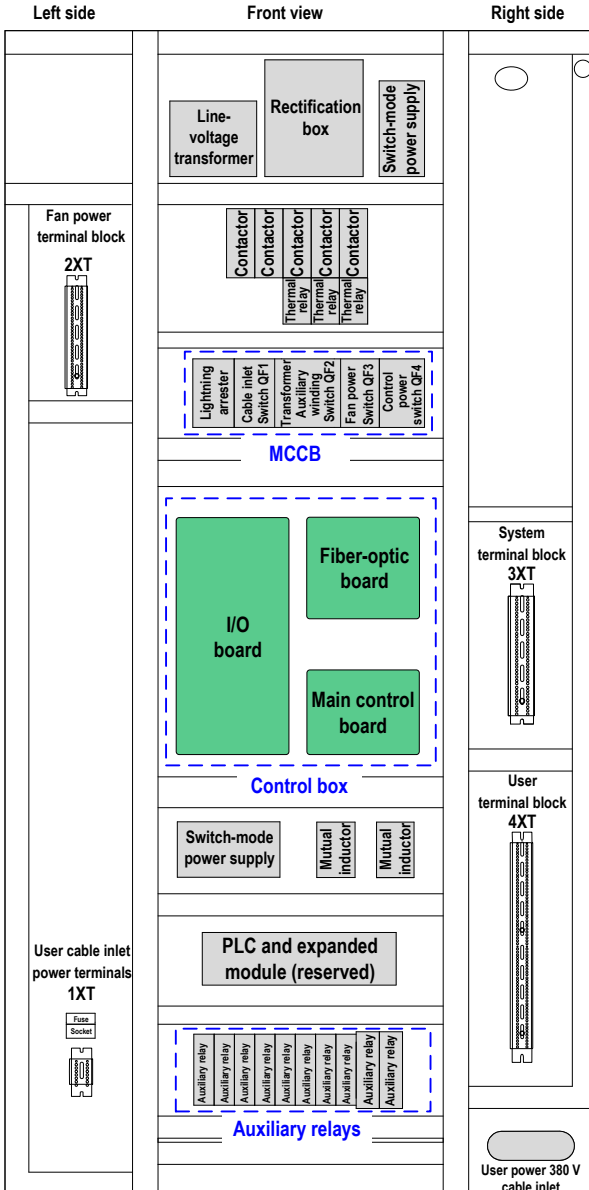
Figure 3-24 Connecting the MV inlet and output terminals



3.3.7 Connecting Control Cables

■ Layout of the Control Circuit Components

Figure 3-25 Layout of the control circuit components



Note

- Figure 3-25 takes the control panel as an example. The component layout in the control cabinet is similar to the layout of the control panel.
- The internal wiring has been completed before delivery. You only need to perform wiring on the user terminal block. For details, refer to the description of the user terminal block.

The main circuit components mainly include the control box, auxiliary relay and MCCB.

- Control box

Table 3-2 Composition of the control box

Name	Function
Main control board	<ul style="list-style-type: none"> • Implement the system logic function, human-machine interaction and communication with bus. • Implement motor control algorithm, real-time protection and cell diagnostics. • Implement phase-shifting PWM output, communication with cells, real-time data exchange with DSP/ARM, and system clock.
I/O interface board	<ul style="list-style-type: none"> • Provide power supply to the whole hardware system, including the main control board and fiber-optic board • Complete conditioning of input and output current/voltage signals • Provide interfaces to other boards, extended cards, HMI, DI/DO and AI/AO, and implementing functions of human-machine interaction, communication and I/O extension
Fiber-optic board	The fiber-optic board is the bridge that connects the control hardware system and power cells.

■ Description of the HD90/DH92 Control Circuit

Table 3-3 Functions of auxiliary relays

Relay Name (Electrical Symbol)	Function
KA1	Control power normal
KA2	Main power indication
KA3	Ready
KA4	Run
KA5	Stop
KA6	Fault
KA7	Alarm
KA8	HMI reset
KA9	Motor 1 in line voltage control indication
KA10	Motor 1 in AC drive control indication
KA11	Motor 1 automatically transferred to line voltage control
KA12	Bypass cabinet cable outlet contactor open
KA13	Standby 1
KJ1	MV switch-on allowed
KJ2	Input MV breaker enable

Note

- If the AC drive is not configured with the bypass cabinet (standard configuration), KA9 to KA13 are standby relays.
- If the AC drive is configured with the manual bypass cabinet, KA11 to KA13 are standby relays.
- If the AC drive is configured with the automatic bypass cabinet, the functions of KA9 to KA12 are as described in Table 3-3.

• Functions of the MCCB

MCCB Name (Electrical Symbol)	Function
QF1	User cable inlet switch
QF2	Transformer auxiliary winding switch
QF3	Fan power switch
QF4	Control power switch

• Wiring of the I/O board

The I/O interface board provides the HD90/HD92 series AC drive with 18-channel digital inputs, 16-channel digital outputs, 4-channel analog inputs and 5-channel analog outputs. The DI, DO, AI and AO terminals can be extended according to the user requirement.

Figure 3-26 Connecting DI terminals

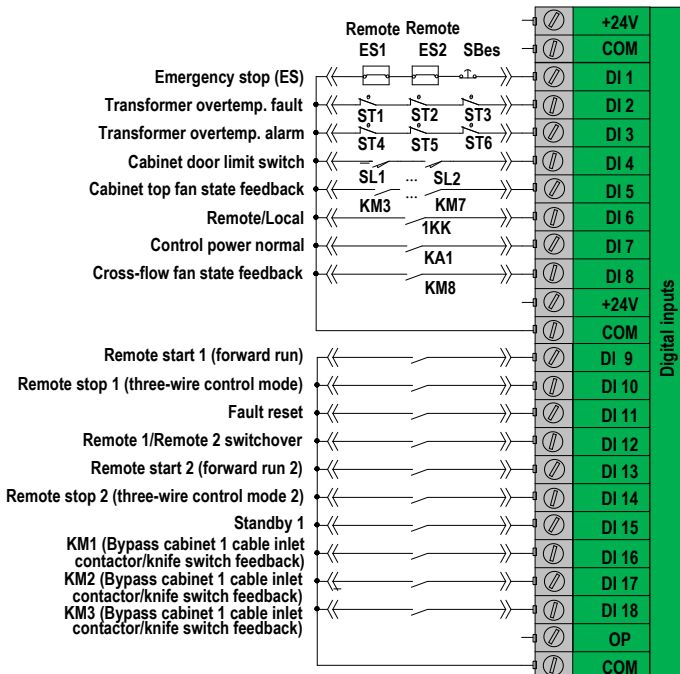


Figure 3-27 Connecting DO terminals

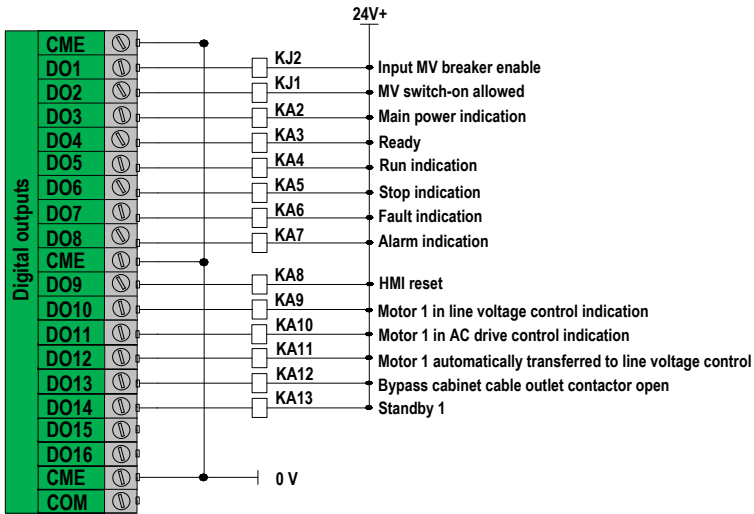
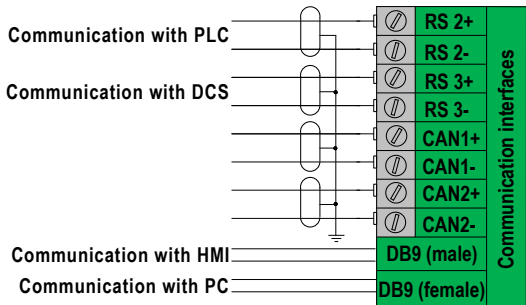


Figure 3-28 Connecting communication terminals



Note

If the Profibus-DP communication card is selected, see Appendix B for the related description.

Figure 3-29 Connecting AI and AO terminals

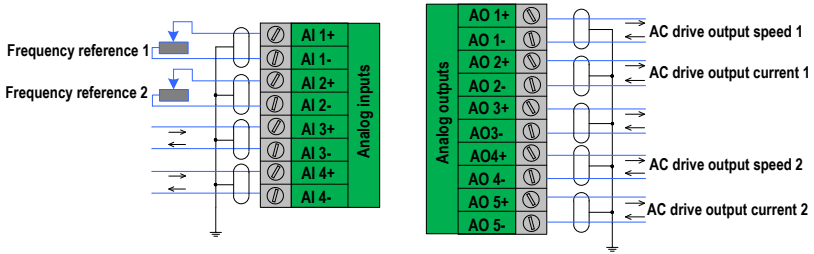
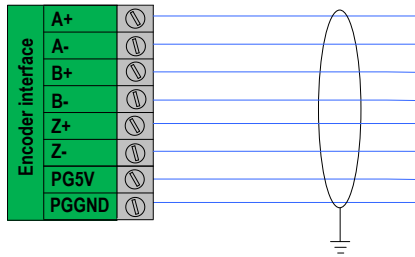


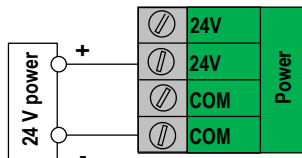
Figure 3-30 Connecting encoder terminals



Note

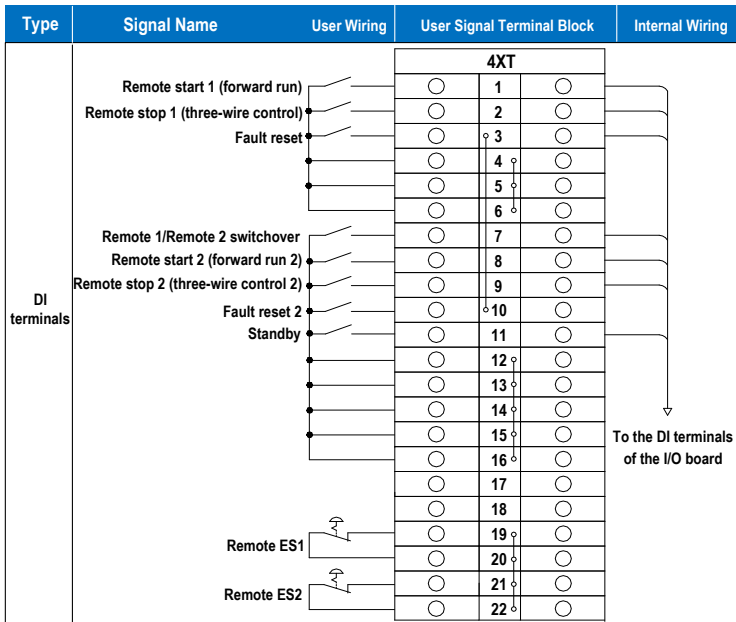
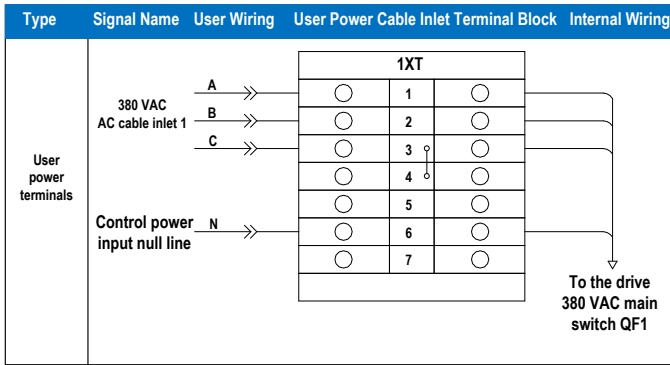
- The encoder is an optional configuration for the HD92 series AC drives. The HD90 series AC drive has no such configuration.
- For detailed description on the encoder, see Appendix C.

Figure 3-31 Connecting the control power

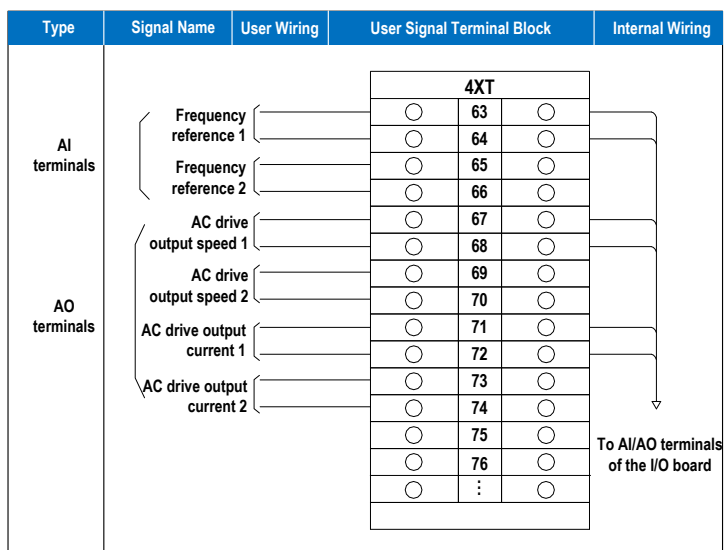


- The user terminal block

The HD90/HD92 series MV AC drive has combined the terminals that the user need to use to the terminal blocks 1XT and 4XT. Follow the following diagrams to wire the terminals.



Type	Signal Name	User Wiring	User Signal Terminal Block	Internal Wiring
DO terminals			4XT	
	Ready 1		23	
	Ready 2		24	
			25	
	Run indication 1		26	
			27	
	Run indication 2		28	
			29	
	Stop indication 1		30	
			31	
	Stop indication 2		32	
			33	
	Fault indication 1		34	
			35	
	Fault indication 2		36	
			37	
	Alarm indication 1		38	
			39	
	Alarm indication 2		40	
			41	
			42	
	Motor 1 in line voltage control indication		43	
			44	
	Motor 2 in line voltage control indication		45	
			46	
	Motor 1 in AC drive control indication		47	
		48		
Motor 2 in AC drive control indication		49		
		50		
Motor 1 automatically transferred to line voltage control		51		
Bypass cabinet cable outlet contactor open		52		
Common		53		
Standby		54		
		55		
		56		
Local/Remote switchover		57		
		58		
MV switch-on allowed		59		
		60		
MV trip		61		
		62		



■ Description of the HD93 Control Circuit

Table 3-4 Functions of auxiliary relays

Relay Name (Electrical Symbol)	Function
KA1	Control power normal
KA2	Main power indication
KA3	Ready
KA4	Run
KA5	Stop
KA6	Fault
KA7	Alarm
KA8	HMI reset
KA9	Excitation start/stop control
KA10	Pre-charge contactor close
KA11	Pre-charge resistor bypass contactor close
KA12	Pre-charge contactor open
KA13	Pre-charge resistor bypass contactor open
KA14	Motor 1 in line voltage control
KA15	Motor 1 in AC drive control
KJ1	MV switch-on allowed
KJ2	Input MV breaker enable

- Functions of the MCCB

MCCB Name (Electrical Symbol)	Function
QF1	User cable inlet switch
QF2	Transformer auxiliary winding switch
QF3	Fan power switch
QF4	Control power switch

- Wiring of the I/O board

The I/O interface board provides the HD93 series AC drive with 18-channel digital inputs, 16-channel digital outputs, 4-channel analog inputs and 5-channel analog outputs. The DI, DO, AI and AO terminals can be extended according to the user requirement.

Figure 3-32 Connecting DI terminals

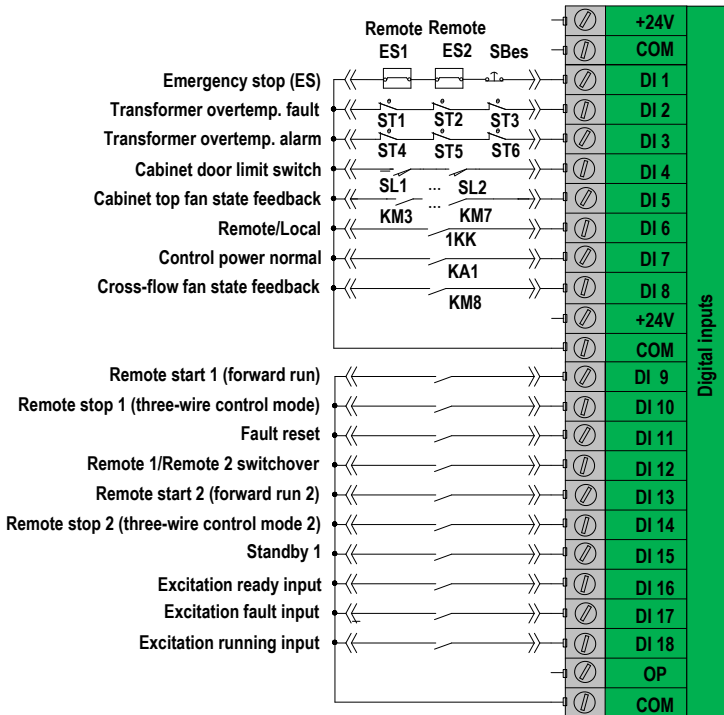


Figure 3-33 Connecting DO terminals

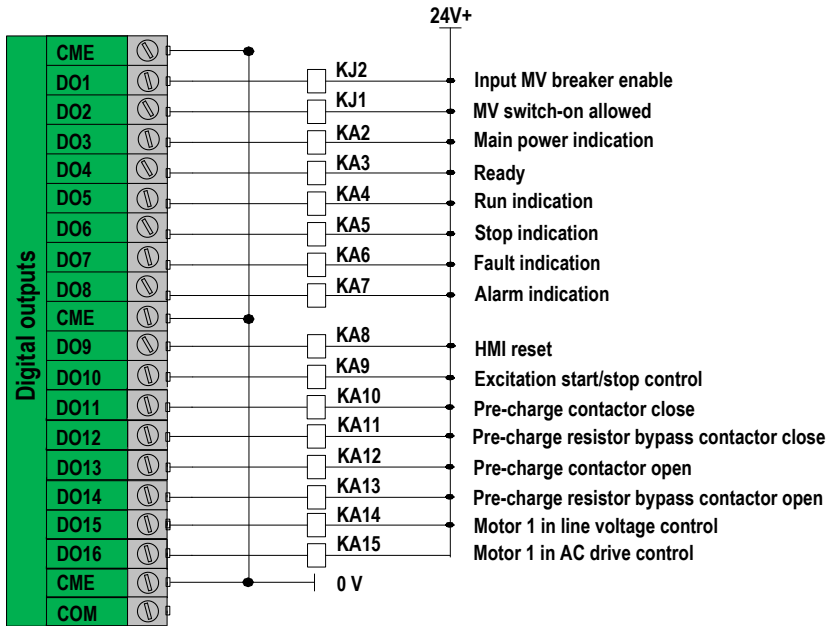
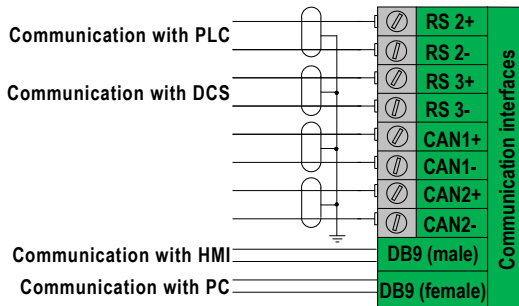


Figure 3-34 Connecting communication terminals



Note

If the Profibus-DP communication card is selected, see Appendix B for the related description.

Figure 3-35 Connecting AI and AO terminals

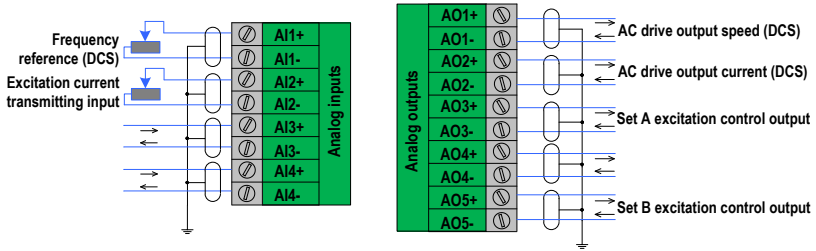
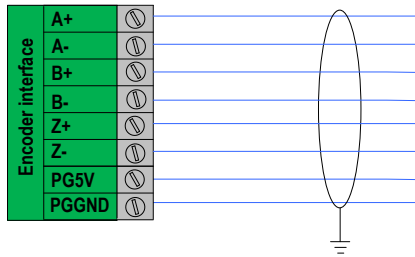


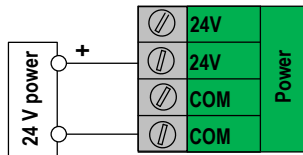
Figure 3-36 Connecting encoder terminals



Note

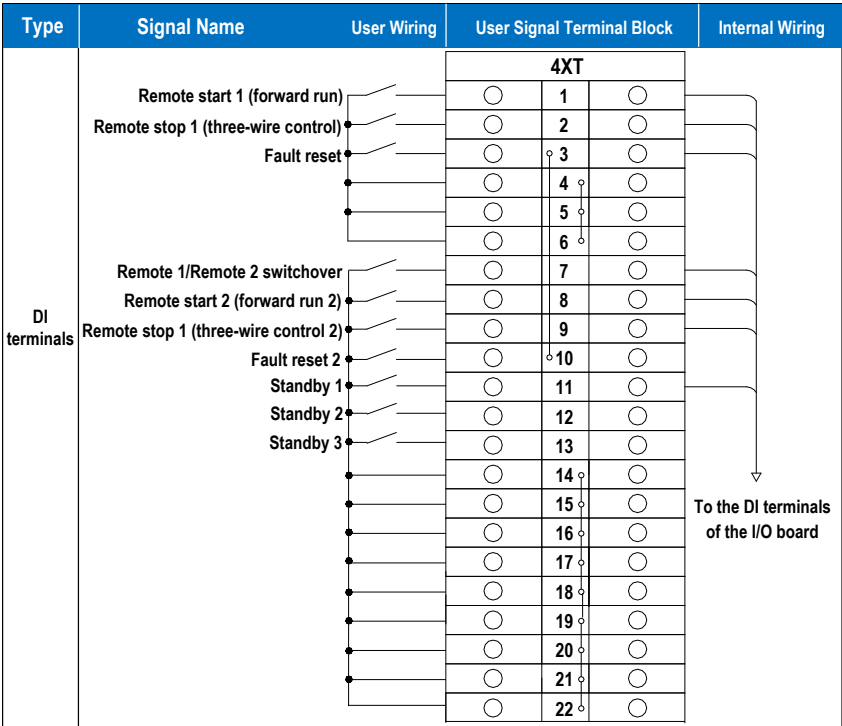
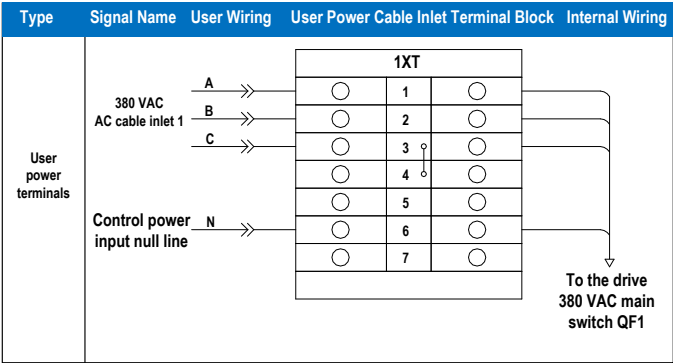
- The encoder is an optional configuration for the HD93 series AC drives.
- For detailed description on the encoder, see Appendix C.

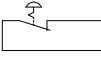
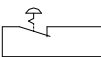




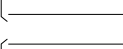



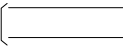





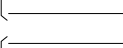





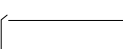



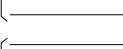

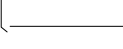





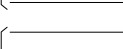

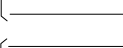

Figure 3-37 Connecting the control power

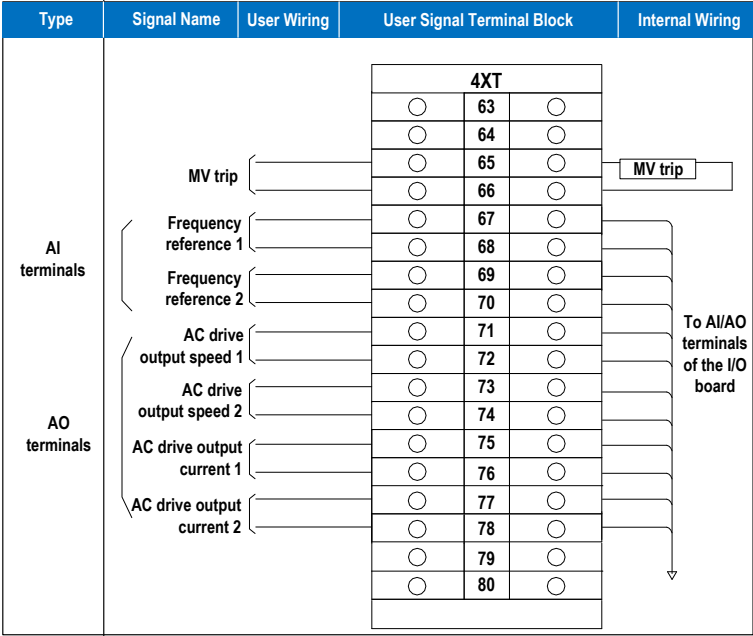


- The user terminal block

The HD93 series MV AC drive has combined the terminals that the user need to use to the terminal blocks 1XT and 4XT. Follow the following diagrams to wire the terminals.



Type	Signal Name	User Wiring	User Signal Terminal Block	Internal Wiring
DO terminals			4XT	
	Remote emergency stop 1		○ 23 ○	
			○ 24 ○	
	Remote emergency stop 2		○ 25 ○	
			○ 26 ○	
	Ready 1		○ 27 ○	 KA3
			○ 28 ○	
	Ready 2		○ 29 ○	 KA3
			○ 30 ○	
	Run indication 1		○ 31 ○	 KA4
			○ 32 ○	
	Run indication 2		○ 33 ○	 KA4
			○ 34 ○	
	Stop indication 1		○ 35 ○	 KA5
			○ 36 ○	
	Stop indication 2		○ 37 ○	 KA5
			○ 38 ○	
	Fault indication 1		○ 39 ○	 KA6
			○ 40 ○	
	Fault indication 2		○ 41 ○	 KA6
			○ 42 ○	
	Alarm indication 1		○ 43 ○	 KA7
			○ 44 ○	
	Alarm indication 2		○ 45 ○	 KA7
			○ 46 ○	
	Motor 1 in line voltage control indication		○ 47 ○	 KA14
			○ 48 ○	
	Motor 2 in line voltage control indication		○ 49 ○	 KA14
		○ 50 ○		
Motor 1 in AC drive control indication		○ 51 ○	 KA15	
		○ 52 ○		
Motor 2 in line voltage control indication		○ 53 ○	 KA15	
		○ 54 ○		
Standby1		○ 55 ○	 KA16	
		○ 56 ○		
Standby1		○ 57 ○	 KA17	
		○ 58 ○		
Standby1		○ 59 ○	 KA18	
		○ 60 ○		
Local/Remote		○ 61 ○	 1KK	
		○ 62 ○		



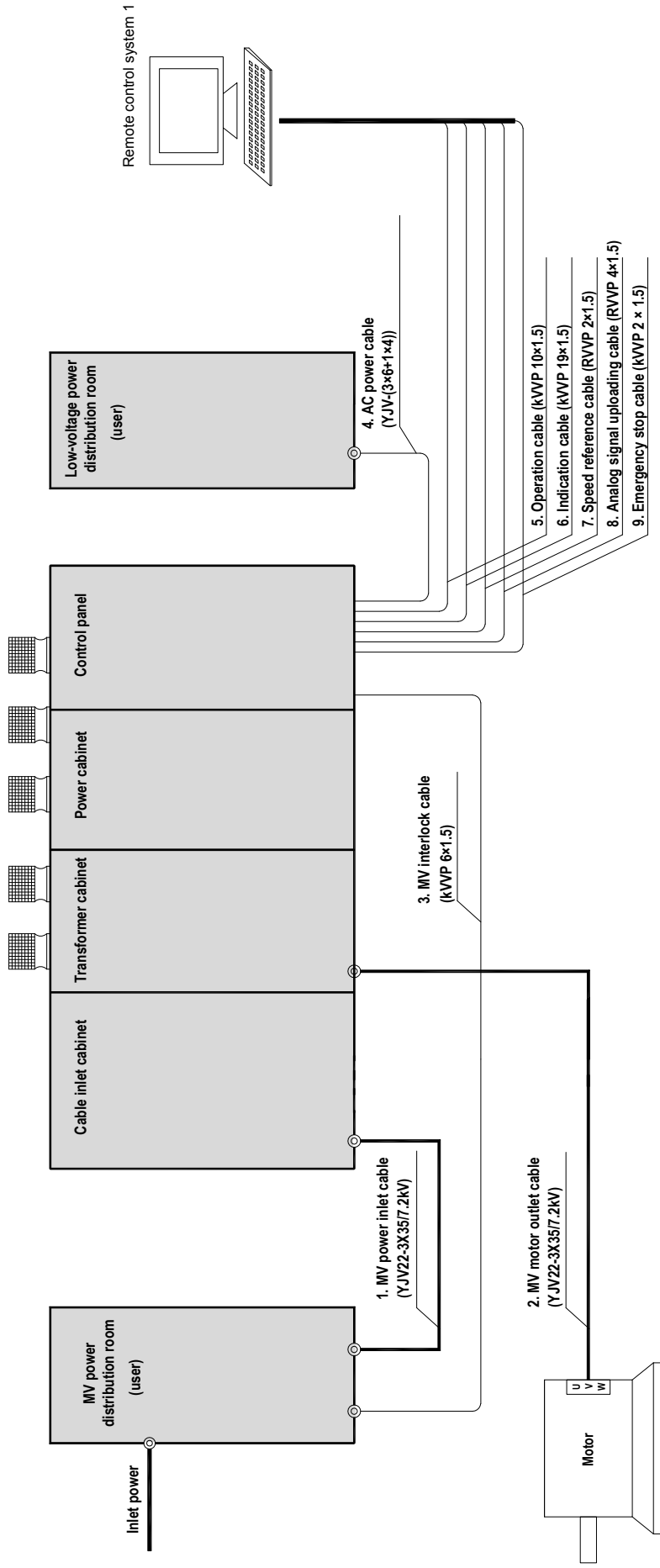
3.3.8 Peripheral Wiring

The peripheral wiring takes the HD90-F60/1120 as an example and is shown in the foldout 1 at the end of this chapter. For the wiring of the equipment you received, refer to the drawing that is delivered together with the equipment.

3.3.9 Typical Application Wiring

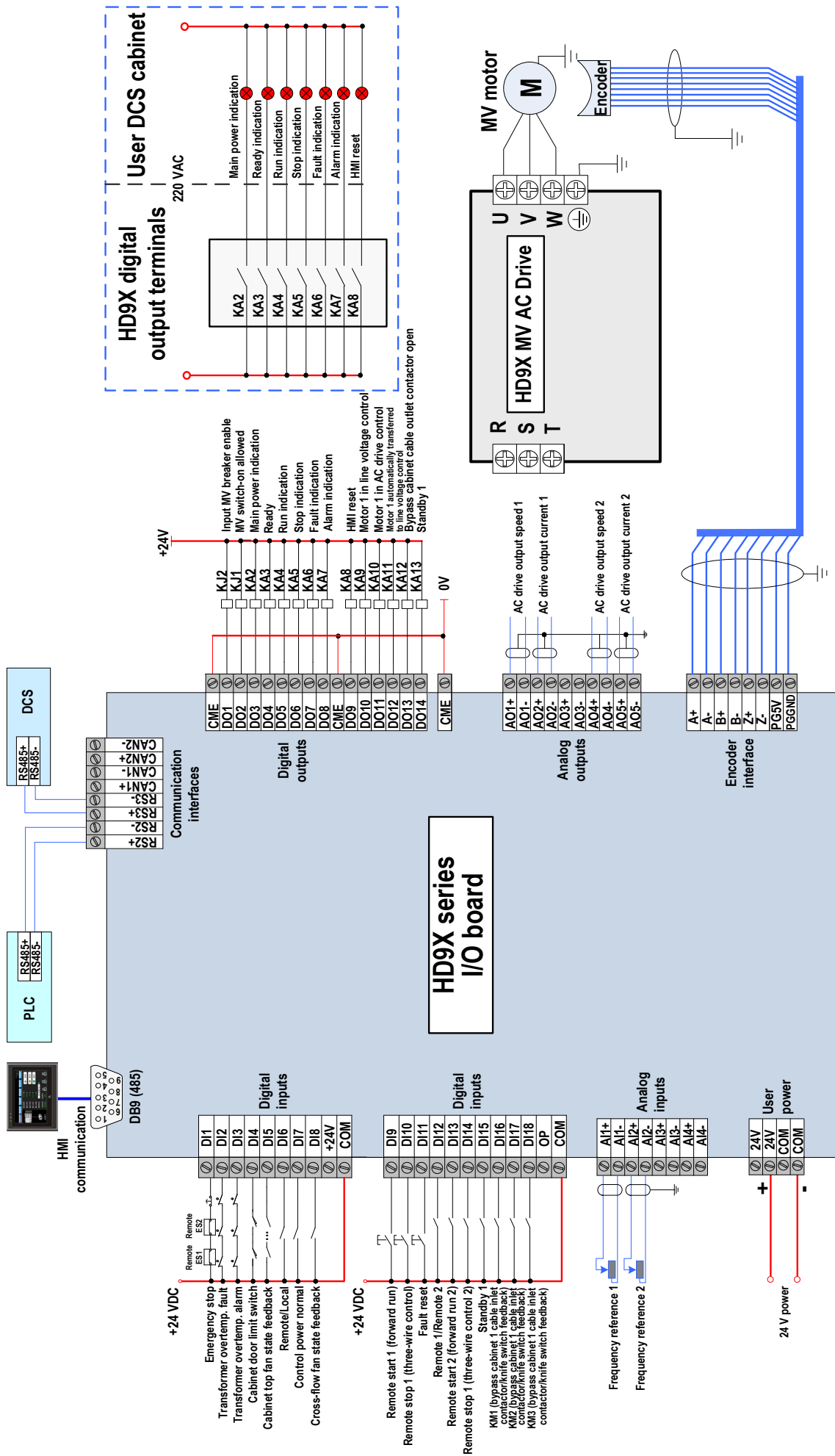
As shown in the foldout 2 at the end of this chapter, all signals are connected to corresponding terminals. Select the signals for connection according to the actual application.

The peripheral wiring takes the HD90-F60/1120 as an example .
 Refer to the drawing that is delivered together with the equipment for actual wiring.



Note:

1. Select STP cable as signal cables.
2. Strictly separate the MV cables from low-voltage cables.





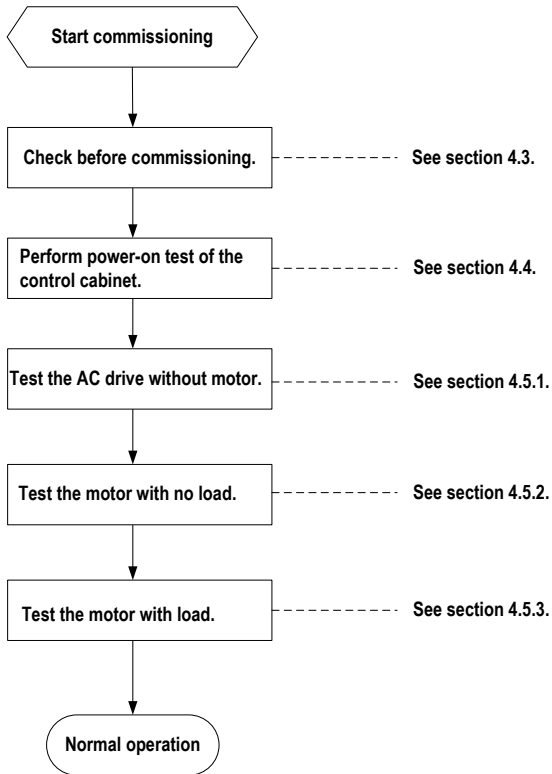
Commissioning and Trial Running

Chapter 4 Commissioning and Trial Running

4.1 Commissioning Procedure

All steps for starting the HD9X from checking before power-on to MV motor test must be performed under guidance of Inovance engineers or only by users who have been trained. The function test, commissioning, and parameter setting must be performed according to related regulations and the instructions in the guide.

Figure 4-1 System commissioning flowchart



4.2 Commissioning Precautions

During commissioning, at least two electric technicians from customers must be available for commissioning, who must:

1. Be familiar with the MV electric equipment and related safety specifications.
2. Be familiar with the load transmission process.
3. Be authorized to operate the MV equipment (such as power circuit breaker and other MV transmission switches).
4. Be authorized to operate the transmission equipment.

WARNING

- Carefully confirm the parameters that have special influence on start to ensure equipment security and normal start.
- If any cabinet door is not closed reliably, a fault will be reported and the switch-on allowed signal will not be output.

WARNING

- Never cut off the control power after the MV power is applied. Otherwise, the cooling, monitoring, and control systems will stop working, which may cause serious faults or damage to the systems.

DANGER

- If the AC drive is not installed or checked properly, the test operations will probably cause severe personal injury or even death.
- Before performing test operations, be sure to cut off the power supply of the AC drive and obey the operation regulations such as using the correct interlock and warning signs.
- Even if the MV circuit breaker and control power switch are turned off, there still may be hazardous voltage in the AC drive cabinet (because of stored energy in the cell).

4.3 Check Before Commissioning and Trial Running

Steps	Checking Items
1	There is no foreign matter inside the cabinet.
2	All electric connections are fastened. The cabinet is intact without damage or serious painting off. If there is damage, check whether the components, cables or other matters surrounding the damaged part are intact.
3	The conductors of cables at the joints and gaps are not exposed due to friction or improper transportation.
4	The AC drive cabinet is reliably tied to the workshop ground.
5	The cables of the AC drive connected to the ground cable of the ground bar are intact and connected securely.
6	The cabinets that are separated during transportation must be connected again with a grounding cable.
7	The fans on the top of the cabinet are mounted solidly and can rotate freely without any abnormal friction noise.
8	The power cables of the fans on the top of the cabinet are connected securely.
9	The wiring between the phase-shifting transformer and the power cells is correct and secure.
10	The optical fibers between the optical fiber board in the main control cabinet and all power cells are connected correctly and securely.
11	All strips of the I/O board are connected correctly and securely. The communication cable between the main control board and the optical fiber board is connected correctly.
12	It is recommended that the analog signal cable provided by the user be shielded cable to guarantee electromagnetic compatibility and be separated from power cables.
13	All user wiring is correct and secure.
14	The control power and main power are connected reliably according to related electrical codes.
15	Apply the power only after ensuring that wiring of the AC drive is correct and all cabinet doors are locked. Never open the cabinet doors after the power is applied.

WARNING

- Be sure that all cabinets are grounded reliably and power cables and power cell cables are connected correctly. Otherwise, it may result in personal injury or equipment damage.

4.4 Power-on Test of Control Cabinet

Steps	Commissioning
1.	Check whether wiring of the control power is correct and whether the voltage is within the specification.
2.	Turn on the power switch (QF1) of the control cabinet and check whether the lightning arrester indicator is ON.
3.	Turn on the fan switch (QF3) of the transformer cabinet and cell cabinet and check whether the fan rotates smoothly in the required direction.
4.	Turn on the 24 VDC control power switch (QF4), and check whether the 24 VDC power supply is normal.
5.	Observe whether the touch screen (HMI) displays normally.
6.	After confirming that the display of the HMI is normal, enter the "Sys. Property" interface. In the pop-up login dialog box, enter the password.
7.	After the login is successful, switch to the "Pr. setting" interface. Input correct motor parameters and related control parameters.
8.	Verify whether the logics of the MV cabinet interlock, emergency stop button, remote/local switch are correct, effective, and reliable.
9.	Go on with the MV power-on test.

4.5 Power-on Test of AC Drive

WARNING

- Before applying MV power, be sure to test whether the input MV breaker can be enabled and disabled properly at interlock with the AC drive.

4.5.1 Test Procedure Without Motor

WARNING

- The input terminals R, S, T and output terminals U, V, W of the AC drive are respectively connected to the yellow, green, and red cables on-site to ensure consistent phase sequence.

Steps	Commissioning
1.	Ensure that the system is in power-off state, and connect the input terminals R, S, T of the AC drive to the MV cabinet. Ensure that the output terminals U, V, W of the AC drive are disconnected from the motor and all cabinet doors are closed.
2.	Apply the AC control power (for the operation, see section 4.4). After the AC drive outputs the MV switch-on allowed signal, and notify the operator that the MV power will be applied.
3.	Apply the MV power according to the operation regulations (for the first-time operation, all personnel must be 3 m away from the cabinet). In case of any abnormality, press the emergency stop button and notify the operator to switch off the MV power immediately.
4.	Verify again that the MV breaker can be enabled reliably at emergency stop.
5.	Observe whether the input voltage is normal after the MV power is applied.
6.	Observe whether the power cells and system alarm or report any fault and whether the display of various states is normal.
7.	Verify basic functions such as start, stop, acceleration, and deceleration.
8.	Verify whether certain alarms and faults can be reported timely and the AC drive can perform related actions correctly.
9.	After ensuring that each power cell is normal, verify the dual power switchover function.
10.	After ensuring that all are normal, stop the AC drive and switch off the MV power.
11.	Go on with the no-load motor test.

WARNING

- Never start/stop the AC drive by switching on/off the MV power.

4.5.2 Motor With No Load Test Procedure

Steps	Commissioning
1.	Ensure that the motor is disconnected from the load.
2.	After the control power and MV power are switched off, connect the motor cables to the output terminals U, V, W of the AC drive securely.
3.	Apply the MV power and ensure that the AC drive self-checking is normal.
4.	Ensure that all parameter settings are correct and perform motor auto-tuning. After the motor auto-tuning is complete, set the frequency reference (5 to 10 Hz for the first time).
5.	Start the AC drive, and check whether the motor rotates in the correct direction (if the line-voltage bypass cabinet is provided on site, test the forward and reverse of the motor in line voltage control) and whether the motor running is normal.
6.	Increase the frequency reference to 50 Hz gradually and then decrease it to 5 Hz several times and observe whether the motor running is abnormal during acceleration and deceleration.
7.	After ensuring that all are normal, stop the AC drive, switch off the MV power, and go on with the with-load motor test.

4.5.3 Motor With Load Test Procedure

Steps	Commissioning
1.	Connect the load to the motor. After all checking is complete, apply the control power and MV power.
2.	After the AC drive is ready, start it on the condition that the load is light. Start the AC drive, and observe the AC drive voltage and current rise as the frequency reference increases. Then, increase the load until meeting the production process requirement.
3.	If an alarm occurs or a fault is reported during start or running, stop the AC drive immediately and perform troubleshooting according to the troubleshooting instructions.
4.	During the trial running, monitor the running on-site for 24 hours. Record the equipment running frequency, transformer temperature, input and output voltage, input and output current and other data.
5.	After 24-hour trial running is complete, the operators will be trained and the duty is transferred.

Note

If the AC drive is not started normally, wait until the motor enters the stop state or wait at least 10 minutes and then start the drive for the second time.



AC Drive Operations

Chapter 5 AC Drive Operations

This chapter describes the operation procedure after the AC drive is installed and commissioned successfully. You are required to follow the operation procedure strictly.

 **DANGER**

Only operators that have been trained and are authorized can operate the AC drive. All operations must be performed according to the safety information and precautions described in Chapter 1.

 **DANGER**

The AC drive is medium-voltage equipment and may endanger the operators. The operators must be familiar with the following precautions before any operation. Otherwise, it will result in personal injury and equipment damage.

5.1 Precautions Before Operation

No.	Precautions Before Operation
1.	Ensure that the input voltage is within the rated range.
2.	When starting a spinning motor, please set and enable the catching a spinning motor function.
3.	The power-on and power-off sequence must be: <ul style="list-style-type: none"> • When starting the system, apply the control power and then the MV power. • When stopping the system, after the motor stops completely, switch off the MV power and then the control power.
4.	Operators must monitor the load running all the time, stops the system immediately if any abnormality occurs, and press the emergency stop button if necessary.
5.	There is no abnormal electromagnetic interference around the AC drive installation location.
6.	Operators must have been trained, be familiar with the AC drive structure, and know the operation procedure, safety information and precautions.
7.	Follow the MV operation regulations during maintenance, such as wearing insulation gloves, insulation shoes, and safety glasses.
8.	Always work with another person present.
9.	Install a security fence (marked with MV danger), and never move it away during operation and maintenance.
10.	Never put combustible materials (including the equipment drawings and user guide) near the AC drive.
11.	When processing or measuring AC drive components, prevent signal cables and control cables from shorting together or touching other terminals.
12.	Never run the AC drive with cabinet doors open, or never open any cabinet door during AC drive running because this will reduce the heat dissipation effect and cause danger.
13.	Stop the cooling fan only after the MV power is switched off. Otherwise, the equipment may get overheated and damaged.
14.	When transporting the AC drive, lay it well in the transporting vehicle and ensure that the ground where the AC is unloaded to is flat.
15.	When maintaining or replacing the power cell, wait for at least 10 minutes after the MV power is switched off and then open the cabinet door. For the waiting time, refer to the label on the AC drive cabinet door. Ensure that the power indicator of power cells are in the off state before operation, because there still may be hazardous MV inside the AC drive a short time after switch-off of the MV power.
16.	After installation and commissioning of the AC drive are complete, the running parameters must not be modified by non-professional personnel. Otherwise, abnormal stop or equipment fault may result.

5.2 Components on Cabinet Door

Figure 5-1 Diagram of the control cabinet panel

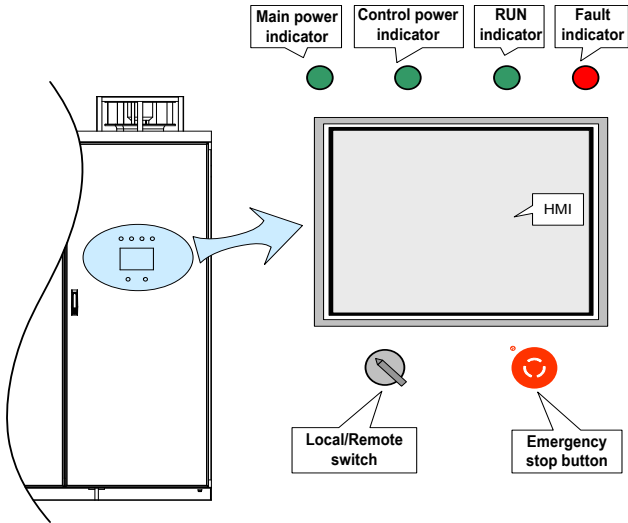


Table 5-1 Description of components on the cabinet panel

Component Name	Function
Emergency stop button	When an emergency fault occurs on the system, press this button to shut off all IGBTs. Then, the AC drive stops output and enables the input MV breaker, reducing the loss to the minimum.
Main power indicator	This indicator indicates whether the MV input is normal. If it is normal, this indicator is ON.
Control power indicator	This indicator indicates whether the 220 VAC control power is normal. If it is normal, this indicator is ON.
RUN indicator	This indicator indicates whether the AC drive is in running state. If yes, this indicator is ON.
Fault indicator	This indicator indicates whether the AC drive is in faulty state. If a fault occurs, this indicator becomes ON.
Local/Remote switch	This switch is used for switchover between local control and remote control.

WARNING

- After pressing the emergency stop button, reset the button by turning it clockwise and then apply the MV power.
- The emergency stop button is invalid when the bypass cabinet is connected to the line voltage. In this case, press the emergency stop button on the bypass cabinet to cut off the MV power.

5.3 Local/Remote Switchover

5.3.1 Local Control

When you turn the Local/Remote switch to "Local", you can directly start and stop the AC drive on the HMI. The target frequency is set via "Frequency reference" on the HMI touch screen.

5.3.2 Remote Control

When you turn the Local/Remote switch to "Remote", the frequency reference and command source can be set via function parameters. Generally, select the DI terminal as the command source and select the AI terminal as the frequency reference setting channel.

Note

The AC drive supports Local/Remote switchover during running and will not stop, but the target frequency may change.

5.4 AC Drive Running Mode

The HD9X series AC drive supports multiple running modes such as open-loop running, closed-loop running, decelerating to stop, and coasting to stop.

5.4.1 Open-Loop Running

In standby state, when the "Local/Remote" switch is turned to "Remote", if there is a remote start command, the AC drive starts based on the acceleration time of the system, and then runs at the frequency reference set by the user.

In standby state, when the "Local/Remote" switch is turned to "Local", the remote startup command is invalid, and you can press "Start" on the HMI to start the AC drive.

5.4.2 Closed-Loop Running

If PID is selected as the frequency reference setting channel, the AC drive runs in closed-loop mode after start. In the closed-loop mode, you can set the desired value of the controlled variables (such as pressure, temperature, converted to 4 to 20 mA analog). Based on the actual values of the controlled variables and PID parameter setting, the AC drive automatically adjusts the motor speed so that the actual values can follow the desired value.

5.4.3 Normal Stop

When the Local/Remote switch is turned to "Remote", the AC drive stops according to the set stop mode once receiving the remote stop command.

When the Local/Remote switch is turned to "Local", the remote startup command is invalid. You can press "Stop" on the HMI to stop the AC drive.

5.4.4 Emergency Stop

In any condition, the emergency stop button on the panel is valid. After receiving the emergency stop command, the system immediately stops output and coasts to stop and meanwhile enables the input MV breaker. The MV switch-on is allowed only after the emergency stop button is reset.

5.5 Alarm/Fault Reset

When an alarm (such as transformer overtemp.) occurs on the system, the alarm is cleared automatically after the system restores to normal. When a fault occurs on the system, you can press "Reset" to reset the fault.

5.6 AC Drive Operation Procedure

DANGER

After the MV power is switched off, wait for at least 10 minutes and then open the cabinet doors to start maintenance. Failure to comply will result in electric shock because the DC bus of the power cell is still energized.

5.6.1 Powering On the AC Drive

1. Power on the control cabinet.
2. Ensure correct setting of the parameters that are related to frequency reference, control mode, and running curve of the AC drive.
3. Close all cabinet doors (the control cabinet door may not be closed).
4. After the MV switch-on allowed signal from the AC drive becomes valid, switch on the pre-charge cabinet.
5. Apply the MV power, and check that the HMI displays "Ready". Then, you can start the AC drive.

WARNING

- Remember to confirm the setting of parameters that have special effect on start to ensure equipment safety and normal start.
- If a cabinet door is not closed properly, the system will report a fault and does not output the switch-on allowed signal.

5.6.2 Starting the AC Drive

1. Power on the system according to the procedure in section 5.6.1.
2. Check that the system state displayed on the HMI is "Ready", and that the fault indicator on the control cabinet is OFF. If an alarm or a fault occurs, perform troubleshooting according to the alarm/fault information displayed on the HMI and the troubleshooting methods described in Chapter 9.
3. Set the frequency reference based on the specified frequency reference setting channel.
4. Give the start signal based on the set control mode.

5.6.3 Stopping the AC Drive

Stop the AC drive based on the set stop mode.

Note

When "Decelerate to stop" is selected, if you give the start signal again before the output frequency decelerates to the stop frequency, the AC drive accelerates again to the frequency reference.

5.6.4 Coasting to Stop

In this stop mode, the AC drive stops voltage output, and the motor coasts to stop (under the effect of load and friction, the motor decelerates gradually to stop)

WARNING

- Estimate whether the process allows the motor to coast to stop.
- When the motor coasts to stop, there is still residual voltage on the output cables due to residual magnetism of the motor.

5.6.5 Powering Off the AC Drive

Except that the MV power can be switched off directly in the case of critical faults, switch off the MV power only after the AC drive stops.

DANGER

The DC voltage reduces to the safety value at least 10 minutes after the MV power is switched off. For the waiting time, refer to the label on the AC drive cabinet door.

5.6.6 Troubleshooting

1. If the main control system is abnormal, press the emergency stop button on the control cabinet to switch off the MV power immediately.
2. The fault levels are graded into minor (alarm), major, and critical. When an alarm occurs, the AC drive continues to run. When a major fault occurs, the AC drive determines whether to continue to run, decelerate to stop, or stop immediately based on the related setting. When a critical fault occurs, the AC drive immediately coasts to stop and disconnects the MV power input.
3. The AC drive stops.
4. Power off the system.
5. Perform troubleshooting 10 minutes after power-off according to the description in Chapter 9.

WARNING

If you pressed the emergency stop button, knob the button clockwise to reset it only after the fault is rectified.

5.6.7 Inspection

DANGER

After the MV power is switched off, wait for at least 10 minutes and then open the cabinet doors to start maintenance. Failure to comply will result in electric shock because the DC bus of the power cell is still energized.

1. Power off the AC drive.
2. Press the emergency stop button to ensure that upper-level MV switch cabinet is in the power cut-off state, ground the grounding switch and set up the warning board.
3. Open the transformer cabinet doors, and tie the grounding cable on the input side of the transformer to the ground reliably.
4. Inspect the transformer cabinet and power cabinet.
5. After inspection is complete, remove the grounding cables on input and output sides of the transformer.
6. Reset the emergency stop button.

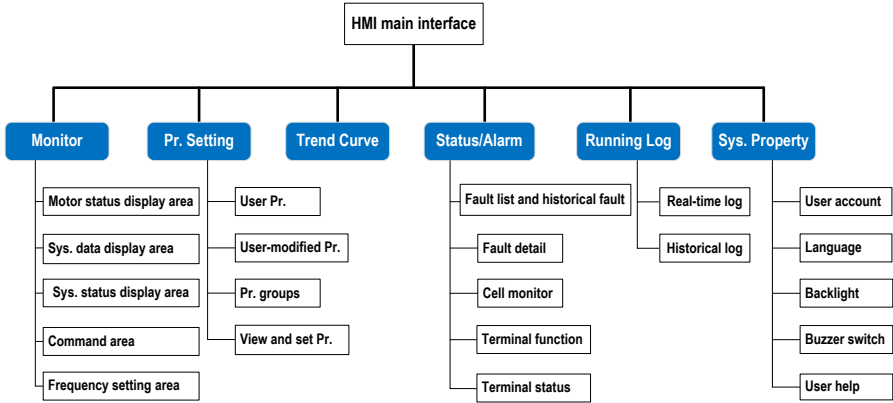


HMI Operation, Display and Applications

Chapter 6 HMI Operation, Display and Applications

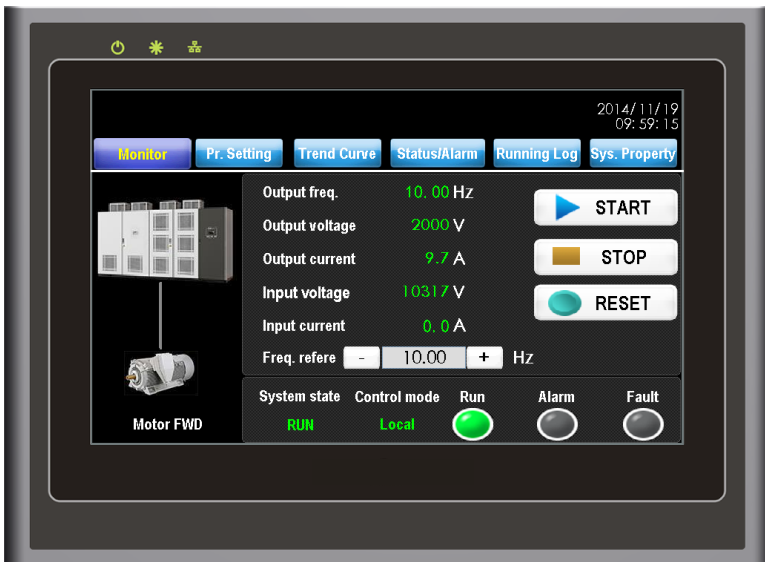
The HD9X is configured with a human-machine interface (HMI). You can set functions and view information of the AC drive by operating the HMI. The following figure shows the functions of the HMI

Figure 6-1 Functions of the HMI



The six functions can be switched over by pressing the tabs. After selecting a function, the tab becomes highlighted. As shown in the following figure, the "Monitor" interface is displayed after power-on by default.

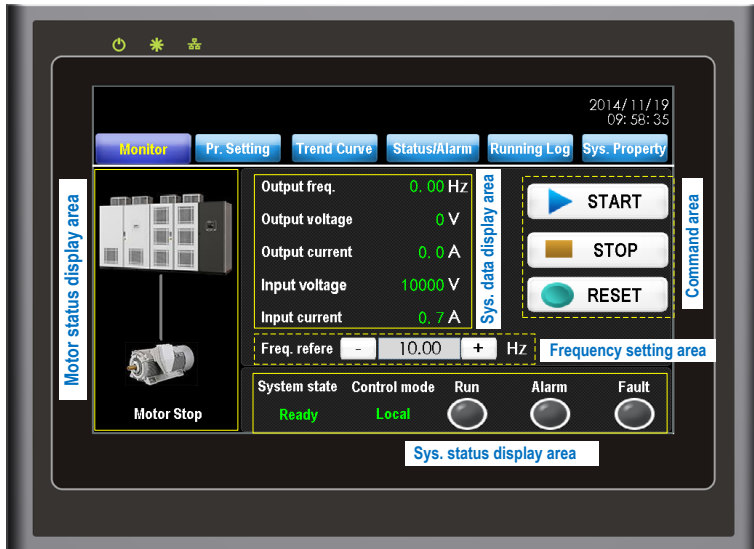
Figure 6-2 System main interface-monitor interface



6.1 Monitor Interface

As shown in Figure 6-3, the monitor interface consists of five areas: the motor status display area, the system data display area, the system state display area, the command area and the frequency setting area.

Figure 6-3 The monitor interface



The functions of the five areas are described in the following table.

Table 6-1 Functions of the five areas



Area Name	Function Description
Motor status display area	Display the motor running state.
Sys. data display area	Display the system commonly used parameters, such as the system output frequency, input and output voltage, and input and output current.
Sys. status display area	Display the current system state , including control mode, running state and fault/alarm state
Command area	Allow you to start/stop the AC drive in the local control mode.
Frequency setting area	Allow you to set the frequency reference through the increment or decrement function or directly input the frequency reference value in the setting box.

1.  **START**

When the system is in the "Ready" state and the frequency reference has been set, press this key and confirm the start operation. The AC drive will run according to the currently set mode. The HMI supports on-line modification of the frequency reference during the drive running. The last frequency reference is considered the target frequency.

2.  **STOP**

Press this key and confirm the operation. The AC drive will stop according to the set stop mode.

In the remote control mode or in the dehumidification state,  **START** and  **STOP** are disabled and do not respond to your operation.

3.  **RESET**

Press this key to reset the system fault. It is valid in either local or remote control mode.

4. Freq. refere

Set the frequency reference here only when the frequency reference setting channel is HMI. It does not take effect if the frequency reference setting channel is not HMI.

5. Alarm/Fault indicator

When a fault or alarm occurs on the system, a fault or alarm information dialog box pops up automatically and the backlight becomes on. "System State" on the interface becomes "System Fault" or "System Alarm", and the corresponding status indicator becomes on or blinks.

6.2 Pr. Setting

The HD9X has many parameters to satisfy requirements of different applications. You can view and modify parameters here and this interface contains four sub-functions.

- User Pr.

The initial interface is "User Pr.". You can quickly adjust the user-level parameters here.

- User-modified Pr.

It is used to display the parameters that are modified to a non-default value.

- Pr. groups

The parameter group from F0-Basic Pr. to A6-Analog and Pulse Pr. are provided. The parameters in these groups can be modified after login with the account of the after-sale level.

- View and set Pr.

After you log in to the after-sales account, input the parameter No. and then view and modify the parameter.

Figure 6-4 The parameter setting interface



6.2.1 User Pr.

It is used to set the commonly used user parameters. Except frequency reference, acceleration time, deceleration time, reference 0 and reference 1 are set in the following parameters respectively.

Pr. Name	Function Code	Pr. Name	Function Code
Acceleration time	F0-17	Reference 0	FC-00
Deceleration time	F0-18	Reference 1	FC-01

6.2.2 User-modified Pr.

It is used to display the parameters that modified to a non-default value. There are a total of three pages and each page supports display of up to eight parameters.



You can switch over display of the pages in a loop by pressing   on the top right corner. As shown in Figure 6-5, F8-53 (Auxiliary function selection) is 0x0001 by default but has been modified to 0x40A1 actually. Thus it is listed into the user-modified parameters.

Figure 6-5 User-modified parameter interface



6.2.3 Parameter Groups


Parameter groups from F0-Basic Pr. to A6-Analog and Pulse Pr. can only be modified after you log in to the after-sales or R&D account. You can view a function code by pressing the left/right arrow on the top right corner or by inputting the parameter No. directly.

The parameter description is updated with the setting value, facilitating on-site operation without user guide.

Figure 6-6 Viewing parameter groups



To modify a parameter, do as follows:

1. Log in to the account of after-sales or a higher level.
2. View the parameter that needs to be modified.
3. Input the new value according to the value description of the parameter below the text box.
4. If the parameter is set incorrectly, the HMI will give a prompt and prohibit parameter downloading.
5. If the parameter is set correctly, press the download arrow . After the HMI prompts "Download succeeds", parameter modification is complete. Then the setting value of the parameter on the current interface will be updated automatically.

Note

If the HMI prompts "Download fails", it may be because the parameter is read-only or can be modified only in the stop state, or the communication is interrupted for short time. Attempt to download the parameter again after the AC drive stops. If download still fails, contact Invoance.

Figure 6-7 Parameter downloading




Figure 6-8 Parameter downloading complete



6.2.4 View and Set Pr.

You can view and set the parameters only after logging in to the after-sales or R&D account. All function parameters can be viewed and set here. To view and set a function parameter, do as follows:

1. Log in with the after-sales or R&D account.
2. Input the No. of the parameter that needs to be viewed or set. If the input is incorrect, the HMI will give a prompt.
3. If the input is correct, you can view the current value of the function code immediately. If the function code also supports writing, you can modify it and then press .
4. If the parameter is downloaded successfully, the HMI prompts "Download succeeds". Press the prompt window to close it. Then you can proceed with other operations.
5. After determining the parameter No., press "Real-time refresh". Then all the parameters you want to view are refreshed successively.

Note

The factory parameters in group FF can be modified only after you log in to the R&D account.

Figure 6-9 View and set parameters



Figure 6-10 Input error prompt (group DA does not exist)



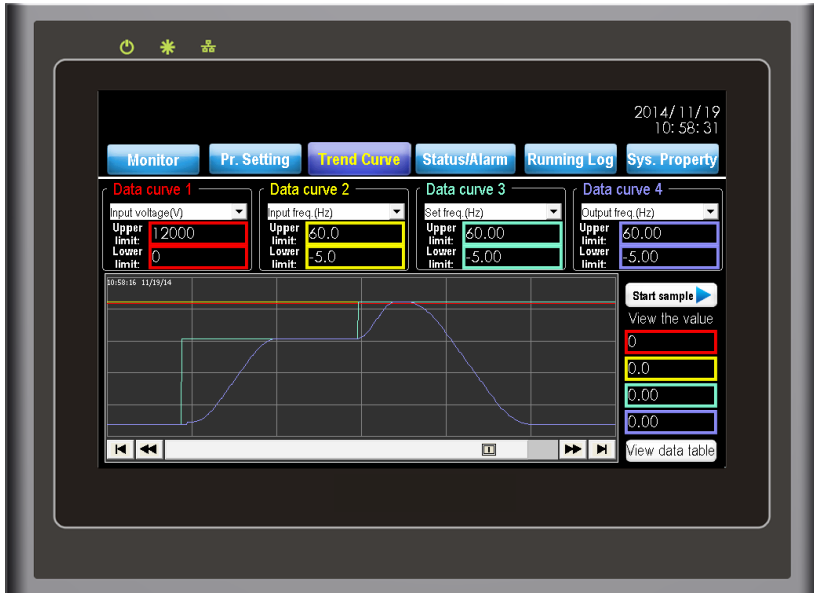
Figure 6-11 Parameter setting successful



6.3 Trend Curve

The "Trend Curve" window facilitates you to keep observing system running parameters visually. It supports the display in the format of either curve or table. The function helps to observe whether the system runs stably.

Table 6-12 Trend Curve window displayed in the curve format



The Trend Curve function has a total of four synchronous signal channels and can save the valid sampling records for the recent 90 days. Each channel supports 32 different observation signals. The real-time signal curves are made in different colors. For example, the signal curve of channel 1 is displayed in red and the corresponding "Upper limit", "Lower limit", "View value" and information in the data table are also displayed in red.

The HMI performs sampling once every 200 ms. The four channels have different data precisions. You can select the proper channel according to actual data precision. The time base is 20s/cell in the "Trend Curve" window. A total of 120s signal waveform can be displayed in a screen.

To view the data in the curve format, do as follows:

1. Select at least one valid signal channel and set its upper limit and lower limit.

If there is no valid signal channel or the upper limit and lower limit are set incorrectly, "Sampling start" will not be started.

2. Press "Sampling start".

The HMI immediately samples the corresponding signals and displays the signals in the curve format. All sampling data will be synchronized to the SD card that is delivered together with the AC drive, facilitating you to view the historical data in the table format.

3. Press any time point of the trend curve to view the data at that moment under "View the value".
4. Press "Sampling stop".

The HMI immediately stops sampling signals of all channels.

Figure 6-13 Trend Curve window displayed in the table format



To view the data in the table format, do as follows:

1. Press "View data table" and "View previous log".
 - 0 indicates the recent day.
 - 1 indicates the day before the recent day, and so on.
 - "View previous" in historical fault and "View previous log" in historical log are defined the same.
 - "Days" in the table indicate consecutive N days from the "View previous" day.
2. The table displays the data in time sequence. View all the data by dragging the scrollbar on the right of the table.

Note

The trend curve function takes effect only after you select a signal channel and press "Sampling start". Otherwise, the HMI does not perform sampling.

6.4 Status/Alarm

It has the following five functions:

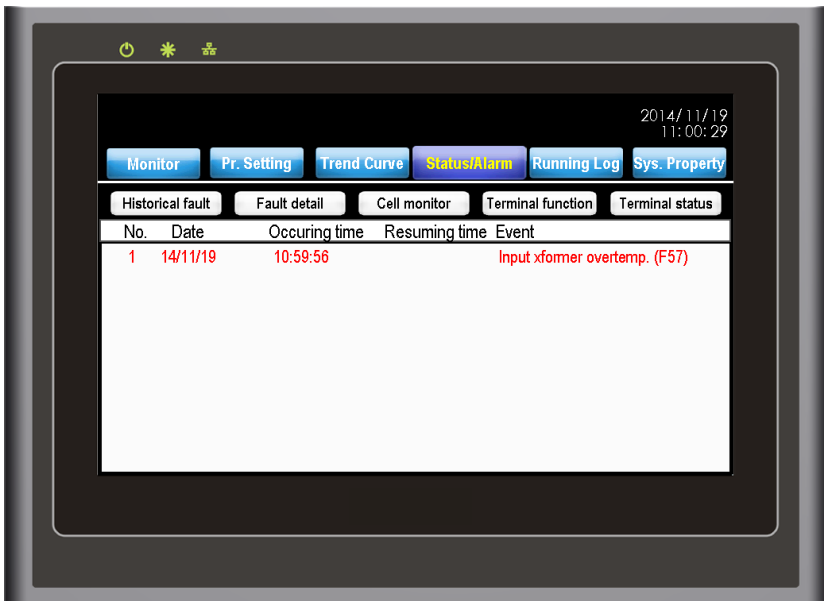
- Fault list and historical fault
- Fault details
- Cell monitor
- Terminal function
- Terminal status

These functions help you to locate system fault, monitor power cells and view status of the I/O interfaces.

6.4.1 Fault List and Historical Fault

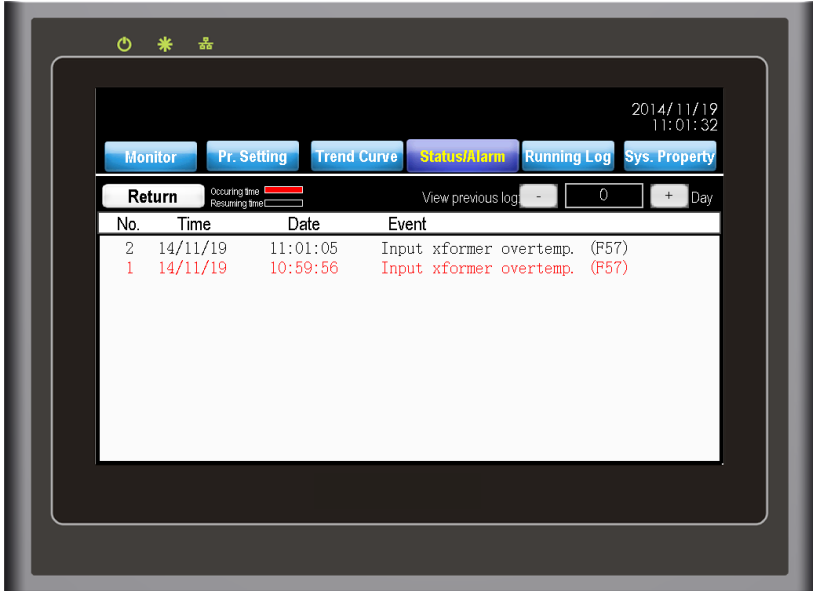
After you press "Status/Alarm" on the main menu, the HMI displays the fault list by default. The list displays all faults and fault occurring/resuming time since recent power-on. It supports the display of recent 100 faults. The fault list will be emptied after you re-power on the control cabinet. But you can view historical fault information by pressing "Historical Fault".

Figure 6-14 List of real-time faults



Press "Historical Fault" to view the historical faults in recent consecutive 255 days after delivery. The faults are displayed on a daily basis. Switch over fault records for two adjacent days by pressing "+" and "-" on the right of "View previous records". The red line in the list indicates the fault occurring time, and the black line indicates the fault resuming time.

Figure 6-15 List of historical faults



6.4.2 Fault Details

The details of faults occurring in the recent 255 days recorded in the SD card are displayed here, including fault occurring time, fault No. and fault subcode, facilitating the maintenance person to analyze the fault and perform troubleshooting.

Figure 6-16 Fault details



6.4.3 Cell Monitor

It is used to display the system topology and the real-time status of all cells. You can see the status (normal, fault and bypass) of all cells in the system topology. The detailed status information of a cell such as bus voltage, cell temperature and version can be viewed after you press the cell.

As shown in Figure 6-17, the AC drive is configured with eight power cells per phase, amongst which cell A1 is faulty and the other ones are normal. As shown in Figure 6-18, communication error occurs on A1.

Figure 6-17 System topology

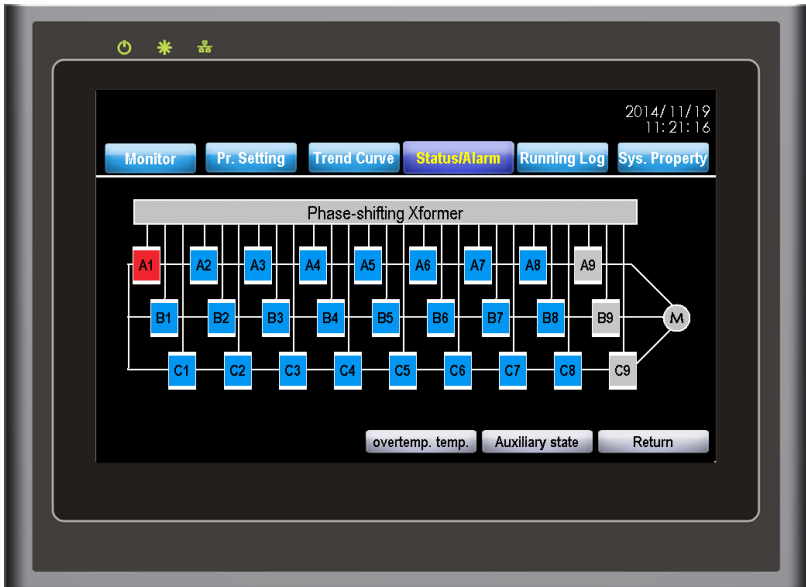


Figure 6-18 Detailed status information of cell A1

The detailed status information for cell A1 is displayed on the screen. The screen shows a list of fault types with checkboxes and a summary of key parameters. The fault types are:

- Cell faults
- Overcurrent
- Undervoltage
- Overvoltage
- overtemp.
- Comm. fault (Upward / Downward / Verification)
- Input phase loss alarm
- Voltage balancing
- Bypass fault
- overtemp. alarm
- Blocking fault

The summary parameters are:

- Bus voltage: 80 V
- Cell Temp.: 24 °C
- CPLD version: 0

Navigation buttons include Monitor, Pr. Setting, Trend Curve, Status/Alarm, Running Log, and Sys. Property. A Return button is located at the bottom left.

Press "Auxiliary state". You can view the bypass contactor self-check state, temperature and bus voltage value of all power cells.

Figure 6-19 Viewing the auxiliary state of power cells



6.4.4 Terminal Function

The HD9X provides the DI/DO terminals with functions. The "Terminal function" is used to display the functions of all DI/DO terminals and whether the current functions are valid.

When the function of a DI/DO terminal is valid, the corresponding function name is green. When it is invalid, the corresponding function name is gray.

If a function is allocated to a DI/DO terminal, the DI/DO terminal is displayed after the function name. If a function is unallocated, no DI/DO terminal is displayed.

As shown in Figure 6-20, DI9 is allocated with "Forward run (FWD)" and the function is invalid currently. DI10 is allocated with "Three-wire control mode" and the function is valid currently.

Figure 6-20 State of DI functions

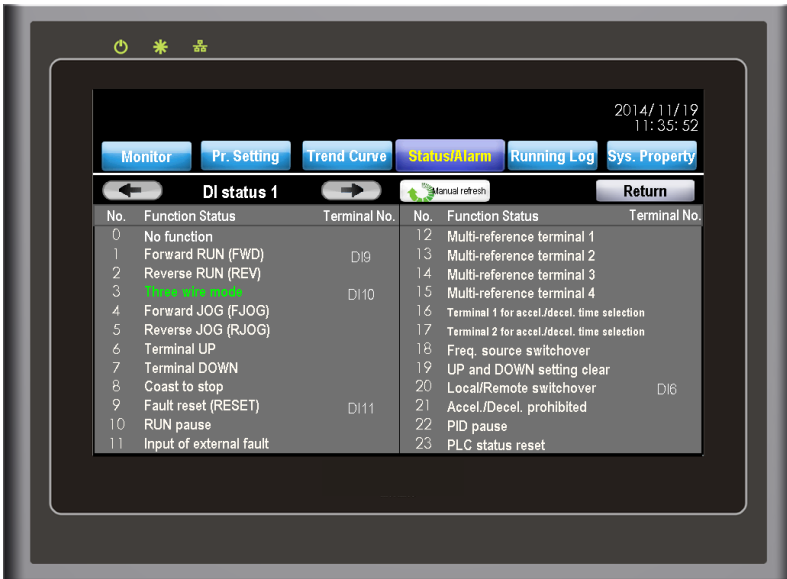



Figure 6-21 State of DO functions



Multiple DO terminals can be set for the same DO function simultaneously. When a DO function is repeatedly allocated,  will be displayed ahead the function No., and the related function parameters will be displayed in scroll.

6.4.5 Terminal Status

The HD9X provides a number of DI, DO, AI and AO terminals. The "Terminal status" function is used to refresh terminal status and analog sampling in real time, facilitating commission engineers to monitor the current signal of terminals.

Figure 6-22 Display of DI/DO level state

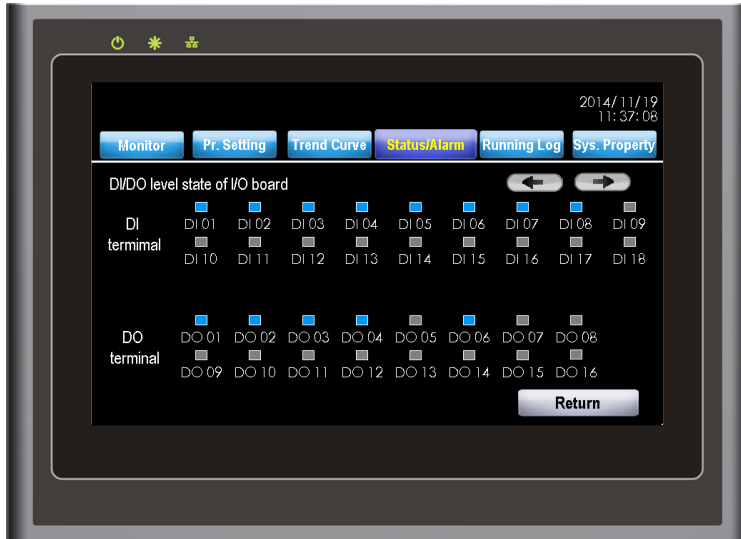


Figure 6-23 Display of AI/AO current



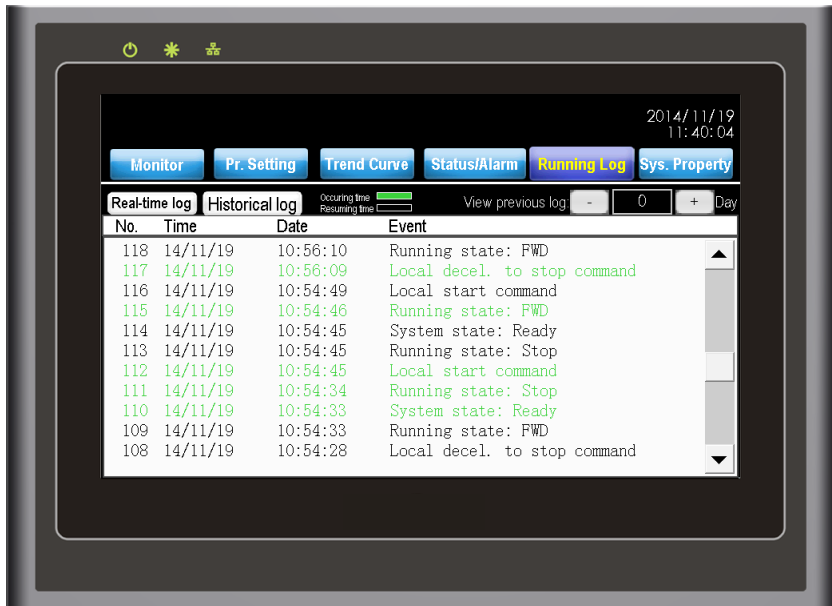
6.5 Running Log

The "Running log" function is used to record the commands, faults/alarms, system status changes and occurring/resuming time of these events in the process of system power-on. Similar to the fault list, "Real-time log" records all running log information from first time power-on of the control cabinet until now. "Historical log" is used to display the running log information of a day of all historical records. All log information is saved in the SD card in special file format for 90 days. You can export the data from the SD card to the PC after logging in within an account of after-sales or a higher level.

Figure 6-24 Viewing real-time log information



Figure 6-25 Viewing historical log information



Press "Real-time log" and "Historical log" to switch over the two viewing modes. After you press "Running log", the HMI displays the real-time log by default. Switch over log records for two adjacent days by pressing "+" and "-" on the right of "View previous log". The green line in the list indicates the event occurring time, the black line indicates the event resuming time, and the red line indicates the system fault occurring time.

6.6 Sys. Property

The "Sys. Property" interface is used to set operation authority and comfort, and view the operation guidance. It consists of the following six functions:

- User account
You can log in to and manage accounts of different levels here.
- Language
It supports simplified Chinese and English
- Backlight brightness
You can adjust the backlight of the HMI. There are a total of 15 levels for option.
- Buzzer switch
It switches on/off the button buzzer.
- User help
It includes the operation guidance, online troubleshooting of common problems and system version list.

Figure 6-26 System property

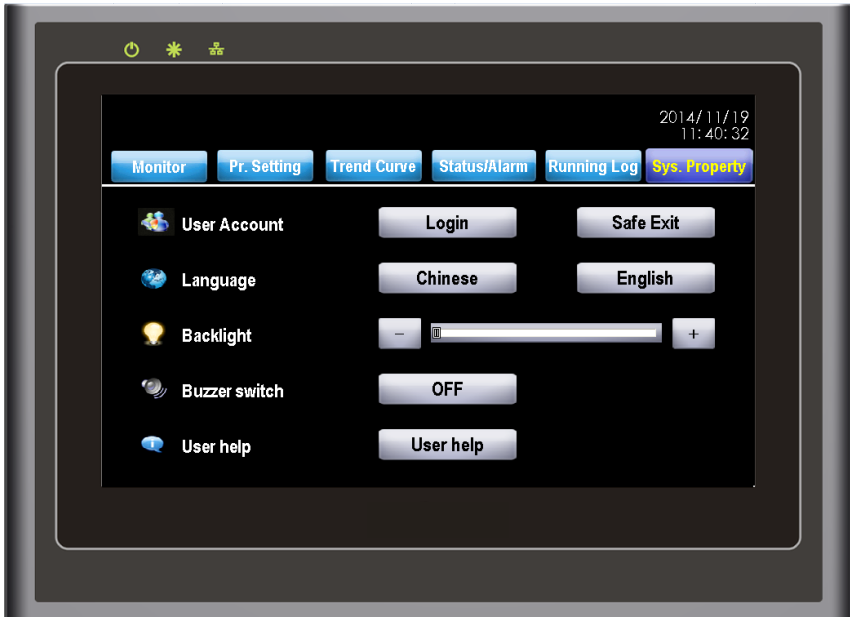
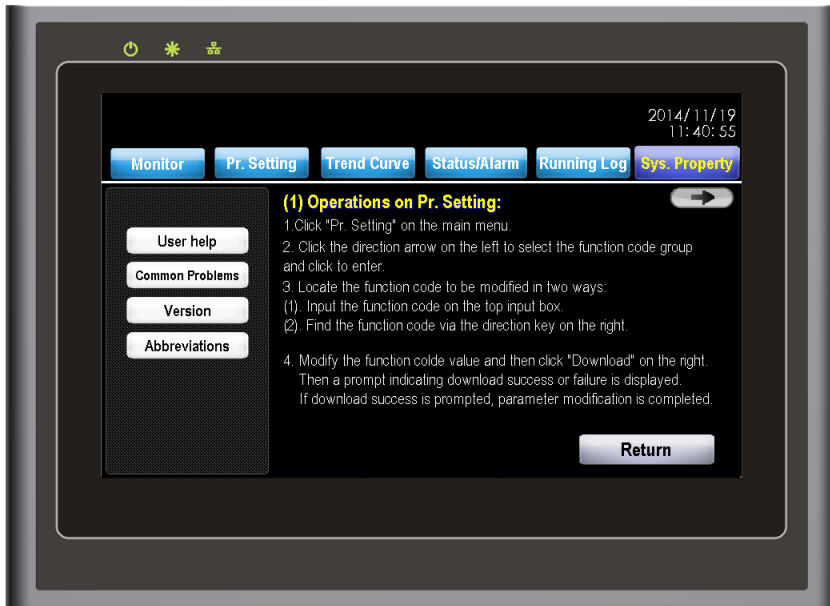


Figure 6-27 User help



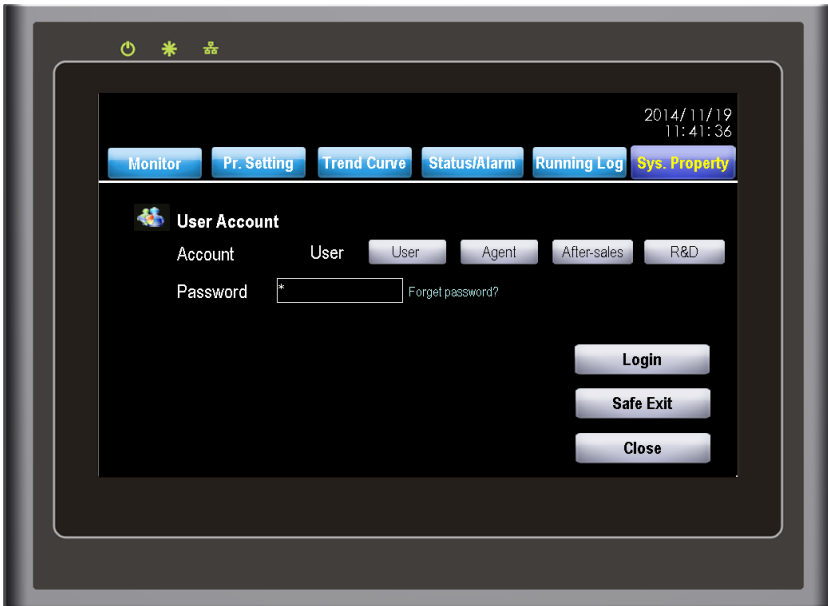
6.6.1 User Account

The system accounts are categorized into four levels: user, agent, after-sales and R&D. After the control cabinet is powered on, the HMI sets no account level by default. This moment, you are authorized only to view information, start/stop the system and set frequency reference.

You can modify "User Pr." in "Pr. Setting" after login with the user account, can modify most parameters after login with the after-sales account, and can modify all parameters after login with the R&D account

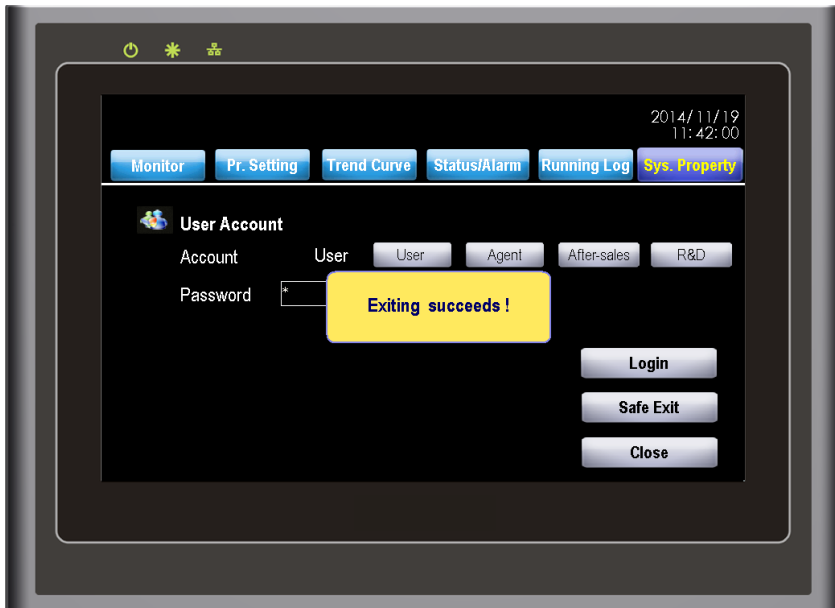
Press "Login" to switch to the account login and management interface. Select the correct account level, input correct password, and then press "Login". The system will display a message indicating login success, as shown in the following figure.

Figure 6-28 Login with the user account



Press "Safe Exit" and "ok". The HMI will log out the current account and prompts "Logout succeeds". The prompt closes automatically 1.5s later.

Figure 6-29 Logout success



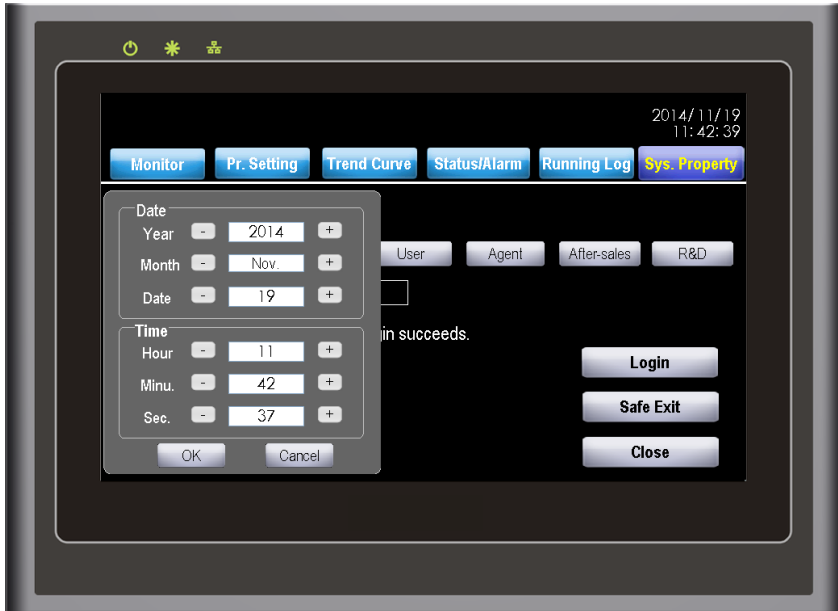
Note

- The initial password of the user account is 1. The password can be changed by the user.
- If the password of the user account is forgotten, the user needs to be authorized after login with the after-sales account and then re-set the password.

6.6.2 Modifying System Time

The HMI displays the system date and time on the top right corner. To modify the system time on the HMI, log in to the system with the account of after-sales or a higher level. Press the system time area. The system time modification window pops out. Modify the system time and press "OK", and then the modification becomes effective. If you press "Cancel", the system time remains unchanged.

Figure 6-30 Modifying system time



6.7 HMI Operation Precautions

The HD9X is a medium voltage device. Any operator must strictly observe the operation instructions.

- Apply control power first and then apply MV power after MV switch-on is allowed.
- When using the HMI, press it slightly with finger. Never knock it or press it with a hard object.
- Never allow irrelevant personnel to use the HMI so as to avoid mal-function.
- The SD card records important system parameters. Only the user of after-sales or a higher level is allowed to insert and plug the SD card.
- Never open cabinet doors when the HD9X MV is running. Failure to comply will result in a danger or system stop due to a fault.

6.8 Starting or Stopping the AC Drive

6.8.1 Selecting the Start/Stop Command Source

There are three start/stop command sources, namely, local, remote 1 and remote 2. The command source is selected through the Local/Remote switch on the control cabinet and the user's remote 1/remote 2 switch.

- Local command source: HMI

The HMI exchanges data with the control system of the AC drive by means of communication. Turn the Local/Remote switch to "Local". Then you can start/stop the AC drive through the HMI.

- Remote 1/Remote 2 command source: terminal control

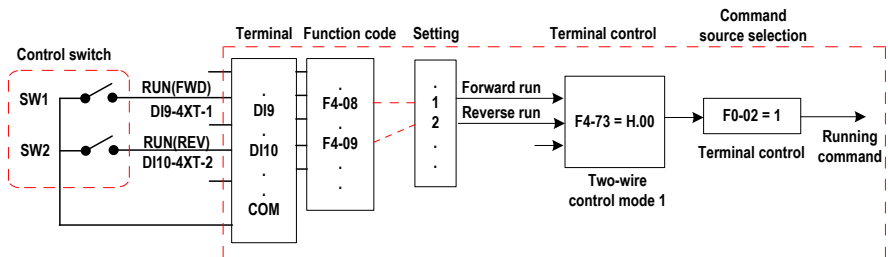
This control mode is applicable to scenarios where the DIP switch or electromagnetic button is used to start or stop the application system or scenarios where the dry contact signal is used to start or stop the AC drive.

The HD9X provides multiple terminal control modes. The switch signal mode is set in F4-73. The input terminal of the start/stop signal is set in F4-08 to F4-17. For details, see the description of F4-73 and F4-08 to F4-17.

Example 1:

To use the DIP switch as the start/stop source, and allocate the forward rotation switch signal to DI9 and the reverse rotation switch signal to DI10, perform the setting as shown in the following figure.

Figure 6-31 Setting of using the DIP switch for start/stop



In Figure 6-31,

- When SW1 is ON, the AC drive instructs forward run command. When SW1 is OFF, the AC drive stops.
- When SW2 is ON, the AC drive instructs reverse run command. When SW2 is OFF, the AC drive stops.
- When SW1 and SW2 are ON or OFF simultaneously, the AC drive stops.

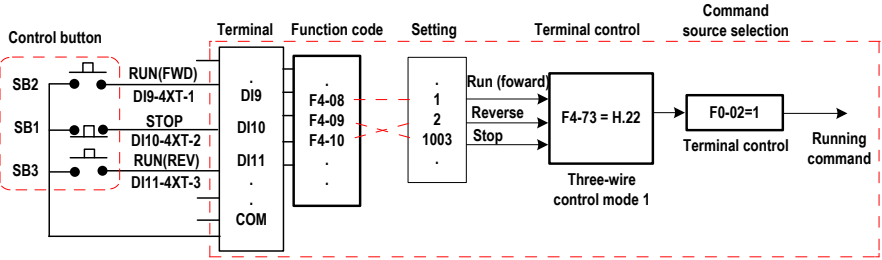
Note

The system prohibits reverse running by default. If reverse running is required in some applications, set F8-13 to 0.

Example 2:

To use the electromagnetic button as the start/stop source, and allocate the start signal to DI9, the stop signal to DI10 and the reverse direction signal to DI11, perform the following setting.

Figure 6-32 Setting of using the electromagnetic button for start/stop



In Figure 6-32

- Once SB1 becomes OFF during normal running, the AC drive stops immediately.
- When the SB1 is in the OFF state, the signals from SB2 and SB3 become valid once they become ON.

6.8.2 Start Mode

The HD9X supports four start modes:

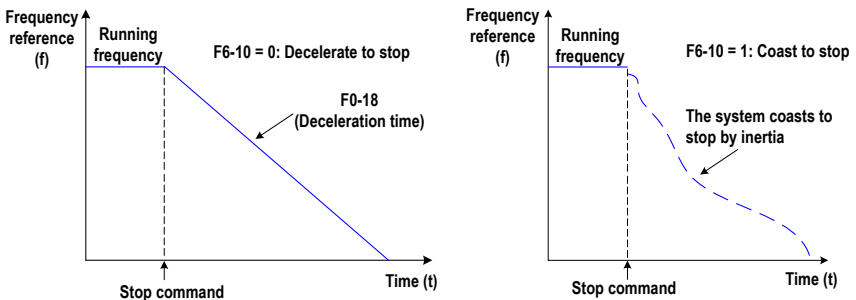
- Direct start
- Catching a spinning motor in forward direction
- Catching a spinning motor in reverse direction
- Catching a spinning motor in both directions

The function is selected in F6-00.

6.8.3 Stop Mode

The AC drive supports two stop modes, decelerate to stop and coast to stop, set in F6-10.

Figure 6-33 Diagram of two stop modes (decelerate to stop and coast to stop)



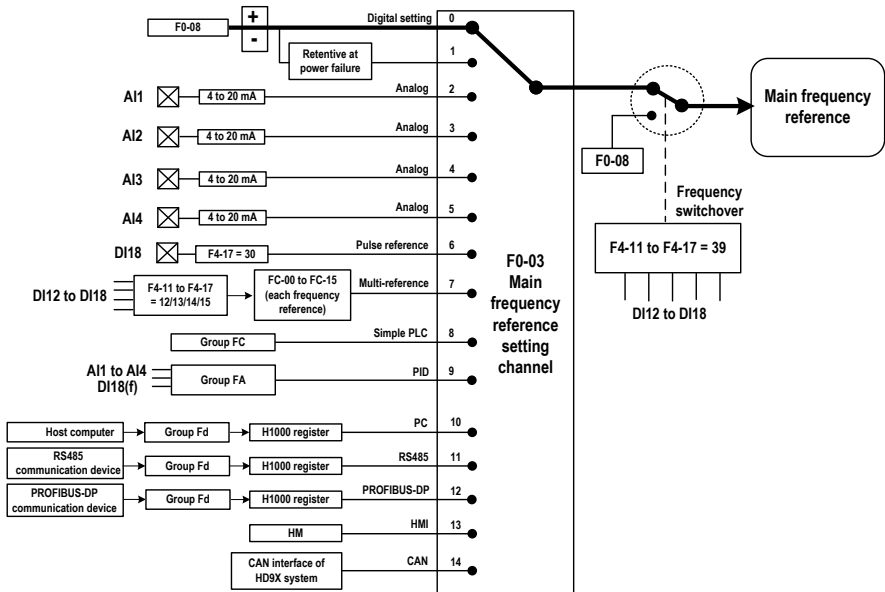
6.9 Control of Frequency Reference of the AC Drive

The HD9X provides a total of 15 frequency reference setting channels.

6.9.1 Main Frequency Reference Setting Channel

There are a total of 15 setting channels of main frequency reference, digital setting (UP/DN modification, non-retentive at power failure), digital setting (UP/DN modification, retentive at power failure), AI1, AI2, AI3, AI4, pulse reference, multi-reference, simple PLC, PID setting, PC, Modbus-RTU, PROFIBUS-DP, HMI and CAN. You can select one in F0-03.

Figure 6-34 Selection of main frequency reference setting channel



According to Figure 6-34, the frequency reference of the AC drive can be set by means of function codes, manual adjustment, analog input, multi-reference, external feedback signal, PID and several communication codes. For details of the parameters in the figure, see their descriptions in Chapter 8.

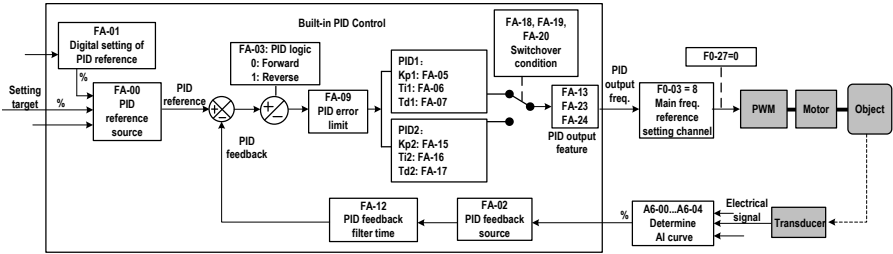
6.9.2 Binding Command Source to Frequency Reference Setting Channel

Command source remote 1 can be bound to its frequency reference setting channel by setting F0-02 and F0-27. For example, if F0-27 is set to H0020 and F0-02 is set to 1, it indicates when the Local/Remote switch is turned to "Remote", the control mode is terminal control 1 and the frequency is determined by AI1. The setting of remote 2 is similar to that of remote 1.

6.9.3 Frequency Reference Controlled by PID

The HD9X has a built-in PID regulator. Together with the frequency reference setting channel, the PID regulator can implement automatic adjustment of process control, such as constant temperature, constant pressure, and tension control.

Figure 6-35 Frequency reference controlled by PID



When PID frequency closed-loop control is implemented, F0-03 (Main frequency reference setting channel selection) must be set to 9 (PID). The PID related parameters are set in group FA.

6.9.4 Setting the Motor Rotating Direction

After the AC drive is ready, press **▶ START** on the HMI to drive the motor to rotate. In this case, the rotation direction is regarded as the forward direction. If the rotation direction is reverse to the direction required by the equipment, power off the AC drive and exchange any two of the output U, V, W cables (wait for at least 10 minutes until the AC drive discharges completely).

6.10 Use of DI Terminals

The HD9X provides a total of 18 DI terminals: DI1 to DI18. Whether it is logic 1 or logic 0 when a DI terminal is active is determined by the setting of the thousand's digit of the DI terminal.

If the thousand's digit of a DI terminal is set to 1, it is logic 1 when the DI terminal is inactive. If the thousand's digit of a DI terminal is set to 0, it is logic 0 when the DI terminal is inactive.

For example, the setting 1 of the thousand's digit indicates active when normally-open.

- If the setting value is 1001, it indicates that the AC drive runs in forward direction when the DI terminal is inactive.
- If the setting value is 1, it indicates that AC drive runs in forward direction when the DI terminal is active.

You can set F4-66 (DI filter time) to improve the anti-interference level of the DI signal, but this will reduce the responsiveness of the DI terminal.

The 18 DI terminals can be allocated with function by setting F4-00 to F4-17. Each DI can be allocated with their respective function according to the electrical diagram. For details, see descriptions of F4-00 to F4-17.

6.11 Use of DO Terminals

The HD9X provides a total of 16 DO terminals. DO1–DO15 are transistor output and DO16 is high-speed transistor output.

You can define the functions of the DO terminals by setting F5-01 and F5-16. The DO terminals are used to output various working states of the AC drive and related signals of control requirements, implementing specific automatic control.

Terminal	Output Signal Characteristic
DO1 to DO15	Transistor Drive capacity: 24 VDC, 50 mA
DO16	Transistor Drive capacity: 24 VDC, 50 mA

When F5-00 = 1, DO16 is high-speed pulse output. The frequency of output pulses indicates the value of the internal running parameters. The greater the value is, the higher the output pulse frequency is. The 100% value corresponds to 50 kHz.

6.12 Use of AI Terminals

The AC drive supports a total of four AI terminals. AI1 and AI2 are internally isolated.

Terminal	Output Signal Characteristic
AI1+, AI1-	Receiving the current signal of 4 to 20 mA
AI2+, AI2-	Receiving the current signal of 4 to 20 mA
AI3+, AI3-	Receiving the current signal of 4 to 20 mA
AI4+, AI4-	Receiving the current signal of 4 to 20 mA

As external voltage/current signal, AI is used for input of frequency reference, torque reference, and PID reference or feedback.

The sampling value of AI can be read on the HMI.

6.13 Use of AO Terminals

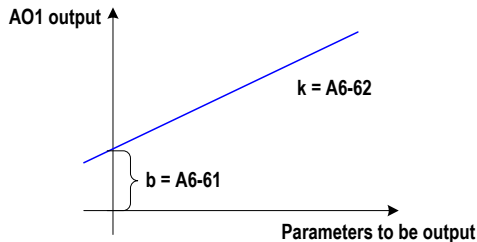
The HD9X provides a total of five AO terminals with output impedance of 0 to 300 Ω. AO1, AO2 and AO3 are internally isolated.

Terminal	Output Signal Characteristic
AO1+, AO1-	Outputting the current signal of 4 to 20 mA
AO2+, AO2-	Outputting the current signal of 4 to 20 mA
AO3+, AO3-	Outputting the current signal of 4 to 20 mA
AO4+, AO4-	Outputting the current signal of 4 to 20 mA
AO5+, AO5-	Outputting the current signal of 4 to 20 mA

AO1 to AO5 can be used to indicate the internal running parameters in the analog mode. The property of indicated parameters can be defined by A6-52 to A6-56.

The designated running parameters can be rectified before output. The rectification feature is $Y = kX + b$, among which "X" indicates the running parameters to be output, "k" and "b" of AO1 can be set by A6-62 and A6-61, "k" and "b" of AO2 can be set by A6-64 and A6-63, "k" and "b" of AO3 can be set by A6-66 and A6-65, "k" and "b" of AO4 can be set by A6-68 and A6-617, and "k" and "b" of AO5 can be set by A6-70 and A6-69.

Figure 6-36 Correction feature curve of AO terminal





Function Parameter Table

Chapter 7 Function Parameter Table

The symbols in the parameter table are described as follows:

Symbol	Meaning
☆	It is possible to modify the parameter with the HD9X in the stop or in the running state.
★	It is possible to modify the parameter with the HD9X only in the stop state.
●	The parameter is read-only.

7.1 Standard Parameters

Function Code	Parameter Name	Setting Range	Default	Property
Group F0: Standard Parameters				
F0-01	Motor 1 control mode	0: Sensorless vector control (SVC1) 1: Closed-loop vector control (CLVC) 2: Voltage-type sensorless vector control (SVC2)	2	★
F0-02	Remote 1 command source selection	0: Operation panel control 1: Terminal control 1 2: Modbus-RTU 3: PROFIBUS-DP 5: PC 6: CAN	1	☆
F0-03	Main frequency setting channel selection	0: Digital setting (non-retentive at power down) 1: Digital setting (retentive at power down) 2: AI1 3: AI2 4: AI3 5: AI4 6: Pulse reference (DI18) 7: Multi-reference 8: Simple PLC 9: PID 10: PC 11: Modbus-RTU 12: PROFIBUS-DP 13: HMI 14: CAN	0	★

Function Code	Parameter Name	Setting Range	Default	Property
F0-08	Preset frequency	0.00 to max. frequency (F0-10)	50.00 Hz	☆
F0-10	Max. frequency	50.00 to 120.00 Hz	50.00 Hz	★
F0-12	Frequency upper limit	Frequency lower limit (F0-14) to maximum frequency (F0-10)	50.00 Hz	☆
F0-14	Frequency lower limit	0.00 Hz to frequency upper limit (F0-12)	3.00 Hz	☆
F0-17	Acceleration time 1	0.0s to 6500.0s	80.0s	☆
F0-18	Deceleration time 1	0.0s to 6500.0s	100.0s	☆
F0-27	Binding remote 1 command source to frequency reference setting channel	0: No binding 1: Digital setting frequency reference 2: AI1 3: AI2 4: AI3 5: AI4 6: Pulse reference (DI18) 7: Multi-reference 8: Simple PLC 9: PID A: PC B: Modbus-RTU C: PROFIBUS-DP D: HMI E: CAN Unit's digit: Binding PC control to the frequency reference setting channel Ten's digit: Binding terminal control to frequency reference setting channel Hundred's digit: Binding Modbus-RTU control to frequency reference setting channel Thousand's digit: Binding PROFIBUS-DP control to frequency reference setting channel	H.0020	☆
F0-29	Remote 2 command source selection	1: Terminal control 2 0, 2 to 6: same as F0-02	1	☆
F0-30	Binding remote 2 command source to frequency reference setting channel	0 to H.EEEE	H.0030	☆

Function Code	Parameter Name	Setting Range	Default	Property
Group F1: Motor 1 Parameters				
F1-01	Rated motor power	1 to 65535 kW	Model dependent	★
F1-02	Rated motor voltage	1 to 65535 V	Model dependent	★
F1-03	Rated motor current	0.1 to 6553.5 A	Model dependent	★
F1-04	Rated motor frequency	0.01 Hz to maximum frequency	Model dependent	★
F1-05	Rated motor speed	1 to 65535 rpm	Model dependent	☆
F1-06	Asynchronous motor stator resistance	0.01% to 30.00%	Auto-tuning parameter	☆
F1-08	Asynchronous motor leakage inductive reactance	0.01% to 50.00%	Auto-tuning parameter	☆
F1-10	Asynchronous motor no-load current	0.01% to 100.00%	Auto-tuning parameter	☆
F1-27	Encoder pulses per revolution	1 to 65535	1024	★
F1-30	A/B phase sequence of ABZ incremental encoder	0: Forward 1: Reserve	0	★
F1-36	Detection threshold of encoder signal loss	0.0%: No detection 0.0% to 70.0%	5.0%	☆
F1-37	Auto-tuning selection	0: No auto-tuning 1: Asynchronous motor static auto-tuning 2: Asynchronous motor complete auto-tuning	0	★

Function Code	Parameter Name	Setting Range	Default	Property
Group F2: Motor 1 Vector Control Parameters				
F2-00	Speed loop proportional gain	0.000–1.000	0.025	☆
F2-01	Speed loop integral gain	0.000–65.535	0.050	☆
F2-09	Drive torque upper limit source in speed control mode	0: F2-10 1: AI1 2: AI2 3: AI3 4: Pulse reference 5: Communication 6: Minimum (AI1, AI2) 7: Maximum (AI1, AI2) 8: AI4	0	☆
F2-10	Digital setting of drive torque upper limit in speed control mode	0.0% to 300.0%	120.0%	☆
F2-12	Digital setting of braking torque upper limit in speed control mode	0.0% to 150.0%	0.3%	☆
Group F4: Input Terminals				
F4-00	DI1 function selection	0 to 83	1031: Emergency stop	●
F4-01	DI2 function selection	0 to 83	1025: Transformer overtemp. fault	●
F4-02	DI3 function selection	0 to 83	1024: Transformer overtemp. alarm	●
F4-03	DI4 function selection	0 to 83	1026: Cabinet door travel switch	●
F4-04	DI5 function selection	0 to 83	1027: Cabinet top fan state feedback	●
F4-05	DI6 function selection	0 to 83	1020: Local/ Remote	●
F4-06	DI7 function selection	0 to 83	33: Control power normal	●
F4-07	DI8 function selection	0 to 83	0	★
F4-08	DI9 function selection	0 to 83	1: Forward run	★

Function Code	Parameter Name	Setting Range	Default	Property
F4-09	DI10 function selection	0 to 83	1003: Three-wire control mode	★
F4-10	DI11 function selection	0 to 83	9: Fault reset	★
F4-11	DI12 function selection	0 to 83	28: Remote 1/ Remote 2	★
F4-12	DI13 function selection	0 to 83	58: Forward run 2	★
F4-13	DI14 function selection	0 to 83	1060: Three-wire control mode	★
F4-14	DI15 function selection	0 to 83	0	★
F4-15	DI16 function selection	0 to 83	0	★
F4-16	DI17 function selection	0 to 83	0	★
F4-17	DI18 function selection	0 to 83	0	★
F4-66	Filter time of DI1 to DI8	0.000s to 1.000s	0.030s	☆
F4-67	DI9 delay	0.0–3600.0s	0.0s	☆
F4-71	DI16 replacement selection	0 to 7	0	★
F4-72	DI17 replacement selection	0 to 7	0	★
F4-73	Terminal command mode	0: Two-wire mode 1 1: Two-wire mode 2 2: Three-wire mode 1 3: Three-wire mode 2 Unit's digit: Terminal command channel 1 Ten's digit: Terminal command channel 2	H.22	★

Function Code	Parameter Name	Setting Range	Default	Property
Group F5: Output Terminals				
F5-01	DO2 function selection	0 to 83	1041: Input MV breaker enable	★
F5-02	DO3 function selection	0 to 83	40: MV switch-on allowed	★
F5-03	DO4 function selection	0 to 83	44: Main power indication	★
F5-04	DO5 function selection	0 to 83	15: Ready	★
F5-05	DO6 function selection	0 to 83	1: Drive running	★
F5-06	DO7 function selection	0 to 83	1001: Drive in stop	★
F5-07	DO8 function selection	0 to 83	2: Fault output	★
F5-08	DO9 function selection	0 to 83	45: Alarm output	★
F5-09	DI10 function selection	0 to 83	46: HMI reset	★
F5-10	DI11 function selection	0 to 83	0	★
F5-11	DI12 function selection	0 to 83	0	★
F5-12	DI13 function selection	0 to 83	0	★
F5-13	DI14 function selection	0 to 83	0	★
F5-14	DI15 function selection	0 to 83	0	★
F5-15	DI16 function selection	0 to 83	0	★
F5-16	DI17 function selection	0 to 83	0	★
F5-69	DO12 delay	0.0s to 3600.0s	0.0s	★
Group F6: Start/Stop Control				
F6-00	DI9 delay	0: Direct start 1: Catching a spinning motor in the forward direction 2: Catching a spinning motor in the reverse direction 3: Catching a spinning motor in the forward/reverse direction	0	☆
F6-10	Stop mode	0: Decelerate to stop 1: Coast to stop	1	☆
F6-16	Current of catching a spinning motor	1.0% to 50.0%	20.0%	☆

Function Code	Parameter Name	Setting Range	Default	Property
Group F8: Auxiliary Functions				
F8-09	Frequency jump 1	0.00 Hz to max. frequency	0.00 Hz	☆
F8-10	Frequency jump 2	0.00 Hz to max. frequency	0.00 Hz	☆
F8-11	Frequency jump band	0.00 Hz to max. frequency	0.00 Hz	☆
F8-13	Reverse control	0: Enabled 1: Disabled	0.00 Hz	☆
F8-18	Start protection selection	0: Disabled 1: Enabled	0.00 Hz	☆
F8-53	Auxiliary function selection	0 to FFFF	H.0001	☆
F8-57	Auxiliary function selection 2	0 to H.FF12	H.0000	☆
Group F9: Protections				
F9-03	Motor overload protection threshold	10.0% to 220.0%	120.0%	☆
F9-06	Motor overvoltage protection threshold	0.0% to 200.0%	125.0%	☆
F9-09	Fault auto reset times	0 to 20	0	☆
F9-11	Time interval of fault auto reset	0.1s to 100.0s	2.0s	☆
F9-30	AC drive overcurrent protection threshold	0.0%–180.0%	150.0%	☆
F9-31	AC drive maximum output current	0.0% to F9-30 - 20.0%	120.0%	☆
Group FA: PID Function				
FA-00	PID reference source	0: FA-01 1: AI1 2: AI2 3: AI3 4: Pulse setting (DI18) 5: Communication setting 6: Multi-reference 7: AI4	0	☆
FA-01	PID digital setting	0.0% to 100.0%	50.0%	☆

Function Code	Parameter Name	Setting Range	Default	Property
FA-02	PID feedback source	0: AI1 1: AI2 2: AI3 3: AI1 - AI2 4: Pulse setting (DI5) 5: Communication setting 6: AI1 + AI2 7: Maximum (AI1 , AI2) 8: Minimum (AI1 , AI2) 9: AI4	0	☆
FA-05	Proportional gain Kp1	0.0 to 100.0	20.0	☆
FA-06	Integral time Ti1	0.01s to 10.00s	2.00s	☆
FA-07	Differential time Td1	0.00s to 10.000s	0.000s	☆
Group FC: Multi-Reference and Simple PLC Function				
FC-00	Reference 0	-100.0% to 100.0%	0.0%	☆
FC-01	Reference 1	-100.0% to 100.0%	0.0%	☆
FC-02	Reference 2	-100.0% to 100.0%	0.0%	☆
FC-03	Reference 3	-100.0% to 100.0%	0.0%	☆
FC-04	Reference 4	-100.0% to 100.0%	0.0%	☆
FC-05	Reference 5	-100.0% to 100.0%	0.0%	☆
FC-06	Reference 6	-100.0% to 100.0%	0.0%	☆
FC-07	Reference 7	-100.0% to 100.0%	0.0%	☆
Group Fd: Communication				
Fd-00	Baud rate	0: 300 bps 1: 600 bps 2: 1200 bps 3: 2400 bps 4: 4800 bps 5: 9600 bps 6: 19200 bps 7: 38400 bps 8: 57600 bps 9: 115200 bps Unit's digit: Modbus-RTU Ten's digit: Reserved Hundred's digit: Reserved Thousand's digit: CANlink	H.5005	☆

Function Code	Parameter Name	Setting Range	Default	Property
Fd-01	Data format symbol	0: No check (8-N-2) 1: Even parity check (8-E-1) 2: Odd parity check (8-O-1) 3: 8-N-1	0	☆
Fd-02	Local address	1 to 247 0: Broadcast address	1	☆
Fd-03	Response delay	0 to 20 ms	2 ms	☆
Fd-04	Communication timeout	0.0s: Invalid 0.1s to 60.0s	0.0s	☆
Fd-05	Data transmission format selection	Unit's digit: Modbus-RTU 0: Non-standard Modbus-RTU protocol 1: Standard Modbus-RTU protocol	1	☆

Group A6: AI Curve and Pulse Parameters

A6-00	AI curve 1 minimum input	0.00 mA to A6-02	4.00 mA	☆
A6-01	Corresponding percentage of AI curve 1 minimum input	-100.00% to 100.0%	0.0%	☆
A6-02	AI curve 1 maximum input	A6-00 to 20.00 mA	20.00 mA	☆
A6-03	Corresponding percentage of AI curve 1 maximum input	-100.00% to 100.0%	100.0%	☆
A6-04	AI1 filter time	0.00s to 10.00s	0.10s	☆
A6-09	AI2 filter time	0.00s to 10.00s	0.10s	☆
A6-52	AO1 function selection	0 to 18	0	☆
A6-53	AO2 function selection	0 to 18	2	☆
A6-54	AO3 function selection	0 to 18	0	☆
A6-55	AO4 function selection	0 to 18	0	☆
A6-56	AO5 function selection	0 to 18	0	☆
A6-61	AO1 zero offset coefficient	-100.0% to 100.0%	20.0%	☆
A6-62	AO1 gain	-100.0% to 100.0%	0.8	☆
A6-63	AO2 zero offset coefficient	-100.0% to 100.0%	20.0%	☆
A6-64	AO2 gain	-100.0% to 100.0%	0.8	☆
A6-65	AO3 zero offset coefficient	-100.0% to 100.0%	20.0%	☆
A6-66	AO3 gain	-100.0% to 100.0%	0.8	☆
A6-67	AO4 zero offset coefficient	-100.0% to 100.0%	20.0%	☆
A6-68	AO4 gain	-100.0% to 100.0%	0.8	☆
A6-69	AO5 zero offset coefficient	-100.0% to 100.0%	20.0%	☆
A6-70	AO5 gain	-100.0% to 100.0%	0.8	☆

7.2 Monitoring Function Parameters

Function Code	Parameter Name	Min. Unit
Group U0: Monitoring Parameters		
U0-00	Running frequency	0.01 Hz
U0-01	Frequency reference	0.01 Hz
U0-02	Input current	0.1 A
U0-03	Output voltage	1 V
U0-04	Output current	0.1 A
U0-05	Output power	1 kW
U0-06	Output torque	0.1%
U0-07	Input voltage	1 V
U0-08	Input frequency	0.1 Hz
U0-09	AI3 current	0.01 mA
U0-10	AI4 current	0.01 mA
U0-15	PID reference	1
U0-16	PID feedback	1
U0-19	Feedback speed	0.1 Hz
U0-24	Input power	1 kW
U0-28	Communication reference	0.01%
U0-29	Encoder feedback speed	0.01 Hz
U0-35	Target torque	0.1%
U0-61	AI1 current	0.01 mA
U0-62	AI2 current	0.01 mA



Function Parameter Descriptions

Chapter 8 Description of Parameters

Group F0: Standard Parameters

Function Code	Parameter Name	Setting Range	Default
F0-01	Motor 1 control mode	0: Sensorless vector control (SVC1) 1: Closed-loop vector control (CLVC) 2: Voltage-type sensorless vector control (SVC2)	2

- 0: Sensorless vector control (SVC1)

It indicates the open-loop vector control, and is applicable to high-performance control applications. One AC drive can operate only one motor.

- 1: Closed-loop vector control (CLVC)

It indicates the closed-loop vector control. The motor must be configured with an encoder and the AC drive provides the PG card matching the encoder type. This control mode is applicable to high-accuracy speed control or torque control applications. One AC drive can operate only one motor.

- 2: Voltage-type sensorless vector control (SVC2)

It also indicates the open-loop vector control, and is applicable to applications without strict load requirements. Compared with SVC1, this control mode has less control accuracy, and is less dependent on motor parameters. One AC drive can operate multiple motors.

The three control modes supported by the HD9X are all vector control, and motor auto-tuning is required for the three control modes. Only accurate motor parameters can achieve good performance of vector control. Better performance can be achieved by adjusting speed regulator parameters in group F2.

Function Code	Parameter Name	Setting Range	Default
F0-02	Remote 1 command source selection	0: Operation panel control 1: Terminal control 1 2: Modbus-RTU 3: PROFIBUS-DP 5: PC 6: CAN	1

It selects the input channel of the AC drive remote 1 control command, such as start, stop, forward run, and reverse run, forward jog and reverse god.

- 0: Operation panel control
Commands are given by the RUN and Stop/RES keys on the operation panel.
- 1: Terminal control 1
Commands are given by means of multi-functional input terminals with functions such as FWD, REV, FJOG, and RJOG.
- 2: Modbus-RTU
Commands are given by means of the Modbus communication.
- 3: PROFIBUS-DP
Commands are given by means of the PROFIBUS-DP communication. When this command source is used, use the communication device that supports the PROFIBUS-DP communication card. For details, see Appendix B: PROFIBUS-DP Card MD38DP2
- 5: PC
Commands are given by clicking the start and stop icons of the PC background software.
- 6: CAN
Commands are given by means of the CAN communication. For details on the communication parameters, see the description of group Fd

Function Code	Parameter Name	Setting Range	Default
F0-03	Main frequency setting channel selection	0: Digital setting (non-retentive at power down) 1: Digital setting (retentive at power down) 2: AI1 3: AI2 4: AI3 5: AI4 6: Pulse reference (DI18) 7: Multi-reference 8: Simple PLC 9: PID 10: PC 11: Modbus-RTU 12: PROFIBUS-DP 13: HMI 14: CAN	0

This function parameter selects the channel to set the main frequency reference. There are a total of 15 channels to set the main frequency reference.

- 0: Digital setting (non-retentive at power down)

The initial value of the frequency reference is F0-08 (Preset frequency). You can change the frequency reference by pressing **and** on the operation panel (or using the UP/DOWN function of the input terminals).

When the HD9X is powered on again after power down, the frequency reference continues from the value of F0-08.

- 1: Digital setting (retentive at power down)

The initial value of the frequency reference is F0-08 (Preset frequency). You can change the frequency reference by pressing **and** on the operation panel (or using the UP/DOWN function of the input terminals).

When the HD9X is powered on again after power down, the frequency reference continues from where it last reached.

Note that F0-23 decides whether the frequency modification is retained at stop rather than at power down.

- 2: AI1
- 3: AI2
- 4: AI3
- 5: AI4

The frequency reference is set by an AI terminal that is 4 to 20 mA current input. AI1 and AI2 are internally isolated.

The HD9X provides two curves indicating the mapping relationship between the input current of AI1, AI2, AI3 and AI4 and the frequency reference. You can set the curves in group A6.

- 6: Pulse reference (DI18)

The frequency reference is set by DI18 (high-speed pulse).

The signal specification of pulse reference is 9 to 30 V (voltage range) and 0.0 to 50.0 kHz (frequency range). Pulse reference can be input only via DI18.

- 7: Multi-reference

In multi-reference mode, combinations of different DI terminal states correspond to different frequency references. The HD9X supports a maximum of 16 references implemented by 16 state combinations of four DI terminals in Group FC. The multiple references indicate percentages of the value of F0-10 (Max. frequency).

If a DI terminal is used for the multi-reference function, you need to set related parameters in group F4. For details, refer to the descriptions of parameters in group F4.

- 8: Simple PLC

When using the simple PLC mode as the frequency reference setting channel, the drive running frequency can be switched over among the 16 frequency references. You can set the holding time and acceleration/deceleration time of the 16 frequency references. For details, refer to the descriptions of Group FC.

- 9: PID

PID control is generally used in on-site process closed-loop control, such as constant pressure closed-loop control and constant tension closed-loop control.

When applying PID as the frequency reference setting channel, you need to set parameters of PID function in group FA.

- 10: PC

The frequency reference is set by means of communication in the background software of the host computer.

- 11: Modbus-RTU

The frequency reference is set by means of the Modbus-RTU communication.

- 12: PROFIBUS-DP

The frequency reference is set by means of the PROFIBUS-DP communication.

- 13: HMI

The frequency reference is set on the HMI.

- 14: CAN

The frequency reference is set by means of the CAN communication.

Function Code	Parameter Name	Setting Range	Default
F0-08	Preset frequency	0.00 to max. frequency (F0-10)	50.00 Hz

This function parameter is the initial value of frequency reference if the frequency reference setting channel is digital setting.

Function Code	Parameter Name	Setting Range	Default
F0-10	Max. frequency	50.00 to 120.00 Hz	50.00 Hz

100% of the analog input, pulse input and multi-reference corresponds to F0-10 when they are used as the frequency reference setting channel.

Function Code	Parameter Name	Setting Range	Default
F0-12	Frequency upper limit	Frequency lower limit (F0-14) to maximum frequency (F0-10)	50.00 Hz

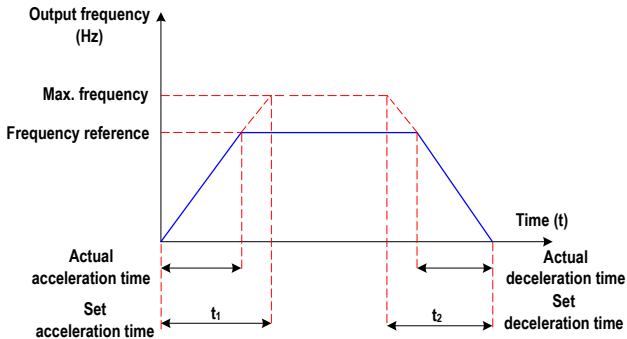
This function parameter sets the frequency upper limit.

Function Code	Parameter Name	Setting Range	Default
F0-14	Frequency lower limit	0.00 Hz to frequency upper limit (F0-12)	3.00 Hz

When the frequency reference is lower than the value of this function parameter, the AC drive runs at the frequency lower limit by default.

Function Code	Parameter Name	Setting Range	Default
F0-17	Acceleration time 1	0.0s to 6500.0s	80.0s
F0-18	Deceleration time 1	0.0s to 6500.0s	100.0s

Figure 8-1 Acceleration and deceleration time



Function Code	Parameter Name	Setting Range	Default
F0-27	Binding remote 1 command source to frequency reference setting channel	0: No binding 1: Digital setting frequency reference 2: AI1 3: AI2 4: AI3 5: AI4 6: Pulse reference (DI18) 7: Multi-reference 8: Simple PLC 9: PID A: PC B: Modbus-RTU C: PROFIBUS-DP D: HMI E: CAN <hr/> Unit's digit: Binding PC control to the frequency reference setting channel <hr/> Ten's digit: Binding terminal control to frequency reference setting channel <hr/> Hundred's digit: Binding Modbus-RTU control to frequency reference setting channel <hr/> Thousand's digit: Binding PROFIBUS-DP control to frequency reference setting channel	H.0020

This function parameter binds the four command sources with the 14 frequency reference setting channels, facilitating to implement synchronous switchover.

For details on the frequency sources, see the description of F0-03 (Main frequency reference setting channel selection).

Different running command sources can be bound to the same frequency reference setting channels.

If a command source has a bound frequency reference setting channel, only the corresponding bound frequency reference setting channel takes effect when the command source is effective.

Function Code	Parameter Name	Setting Range	Default
F0-29	Remote 2 command source selection	1: Terminal control 2 0, 2 to 6: same as F0-02	1

This function parameter selects the input channel of the AC drive remote 2 control commands. For details, see the description of F0-02. You can select one communication protocol each time.

If remote 2 command source is selected, you must set this parameter properly.

Function Code	Parameter Name	Setting Range	Default
F0-30	Binding remote 2 command source to frequency reference setting channel	0 to H.EEEE	H.0030

This parameter is set in the same way as F0-27.

Group F1: Motor 1 Parameters

Function Code	Parameter Name	Setting Range	Default
F1-01	Rated motor power	1 to 65535 kW	Model dependent
F1-02	Rated motor voltage	1 to 65535 V	Model dependent
F1-03	Rated motor current	0.1 to 6553.5 A	Model dependent
F1-04	Rated motor frequency	0.01 Hz to maximum frequency	Model dependent
F1-05	Rated motor speed	1 to 65535 rpm	Model dependent

Set these parameters according to the motor nameplate no matter whether open-loop or closed-loop vector control is used.

To achieve better open-loop or closed-loop vector control performance, you need to perform motor auto-tuning. The motor auto-tuning accuracy depends on the correct setting of motor nameplate parameters.

Function Code	Parameter Name	Setting Range	Default
F1-06	Asynchronous motor stator resistance	0.01% to 30.00%	Auto-tuning parameter
F1-08	Asynchronous motor leakage inductive reactance	0.01% to 50.00%	Auto-tuning parameter
F1-10	Asynchronous motor no-load current	0.01% to 100.00%	Auto-tuning parameter

These parameters are obtained through motor auto-tuning. Only F1-06 to F1-08 can be obtained through static motor auto-tuning. Through complete motor auto-tuning, F1-10, the encoder phase sequence and current loop PI parameters can be obtained besides F1-06 to F1-08.

If motor auto-tuning cannot be performed on site, manually input the values of these parameters according to data provided by the motor manufacturer. It is recommended that static motor auto-tuning is performed.

Function Code	Parameter Name	Setting Range	Default
F1-27	Encoder pulses per revolution	1 to 65535	1024

This parameter is used to set the pulses per revolution (PPR) of the ABZ or UVW incremental encoder. In CLVC mode, the motor cannot run properly if this parameter is set incorrectly.

Function Code	Parameter Name	Setting Range	Default
F1-30	A/B phase sequence of ABZ incremental encoder	0: Forward 1: Reserve	0

This parameter is valid only for the ABZ incremental encoder and is used to set the A/B phase sequence of the ABZ incremental encoder.

It is valid for both asynchronous motor and synchronous motor. The A/B phase sequence can be obtained through complete auto-tuning.

Function Code	Parameter Name	Setting Range	Default
F1-36	Detection threshold of encoder signal loss	0.0%: No detection 0.0% to 70.0%	5.0%

It is used to set the detection threshold of detecting the encoder signal lost fault. When it is set to 0.0%, the AC drive does not detect the encoder signal lost fault.

When the deviation between the encoder feedback speed and the internal evaluation speed is larger than the value of this parameter, the AC drive reports fault F20.

Function Code	Parameter Name	Setting Range	Default
F1-37	Auto-tuning selection	0: No auto-tuning 1: Asynchronous motor static auto-tuning 2: Asynchronous motor complete auto-tuning	0

- 0: No auto-tuning

Auto-tuning is prohibited.

- 1: Asynchronous motor static auto-tuning

It is applicable to scenarios where complete auto-tuning cannot be performed because the asynchronous motor cannot be disconnected from the load.

Before performing static auto-tuning, properly set the motor nameplate parameters F1-01 to F1-05 first. If the AC drive is in the CLVC mode, you also need to set the encoder PPR in F1-27.

Set this parameter to 1, and press "Start". Then, the AC drive starts static auto-tuning. During static motor auto-tuning, there is current in the motor, but the motor will not rotate or only rotate slightly.

- 2: Asynchronous motor complete auto-tuning

You must select the complete auto-tuning to ensure the dynamic control performance of the AC drive. In this case, disconnect the load from the motor.

During the process of complete auto-tuning, the AC drive performs static auto-tuning first and then accelerates to 30% of the rated motor frequency within the acceleration time set in F0-17. The AC drive keeps running for a certain period and then decelerates to stop within the deceleration time set in F0-18.

Before performing complete auto-tuning, properly set the motor nameplate parameters of F1-00 to F1-05, the encoder type and the encoder PPR in F1-27 and F1-28.

By complete auto-tuning, the AC drive will obtain motor parameters of F1-06, F1-08, and F1-10, encoder AB phase sequence in F1-30, vector control current loop PI parameters of F2-13 to F2-16.

Set this parameter to 2, and press "Start". Then, the AC drive starts complete auto-tuning.

To perform auto-tuning on the HMI, set local control and log in to the HMI with the after-sales password. Switch to the parameter setting interface and change the setting of F1-37 to static auto-tuning or complete auto-tuning. After the parameter is downloaded successfully, in the Start/Stop dialog box that is displayed, press "Start" and the motor auto-tuning starts.

Group F2: Motor 1 Vector Control Parameters

Function Code	Parameter Name	Setting Range	Default
F2-00	Speed loop proportional gain	0.000–1.000	0.025
F2-01	Speed loop integral gain	0.000–65.535	0.050

The speed dynamic response characteristics in the vector control mode can be adjusted by setting the PI function: proportional gain and integral gain.

To achieve a faster system response, increase the proportional gain and reduce the integral gain. Be aware that this may lead to system oscillation.

The recommended adjustment method is as follows:

If the default setting cannot meet the requirements, make proper adjustment. Increase the proportional gain first to ensure that the system does not oscillate, and then reduce the integral gain to ensure that the system has quick response and small overshoot.

Note

Improper PI parameter setting may cause too large speed overshoot, and overvoltage fault may even occur when the overshoot drops.

Function Code	Parameter Name	Setting Range	Default
F2-09	Drive torque upper limit source in speed control mode	0: F2-10 1: AI1 2: AI2 3: AI3 4: Pulse reference 5: Communication 6: Minimum (AI1, AI2) 7: Maximum (AI1, AI2) 8: AI4	0
F2-10	Digital setting of drive torque upper limit in speed control mode	0.0% to 300.0%	120.0%
F2-12	Digital setting of braking torque upper limit in speed control mode	0.0% to 150.0%	0.3%

In the speed control mode, the maximum output torque of the AC drive is restricted by F2-09. F2-09 and F2-10 specify the torque upper limit in the motoring state. F2-12 specify the torque upper limit in the generative state.

When the torque upper limit source is analog, pulse or communication reference, 100% of the setting corresponds to F2-10, and 100% of F2-10 corresponds to the rated motor torque.

Group F4: Input Terminals

The HD9X provides a total of 18 multi-functional DI terminals (DI18 can be used for high-speed pulse input). If more DI terminals are required, use an extension I/O board or configure a PLC optional module.

Function Code	Parameter Name	Setting Range	Default
F4-00	DI1 function selection	0 to 83	1031: Emergency stop
F4-01	DI2 function selection	0 to 83	1025: Transformer overtemp. fault
F4-02	DI3 function selection	0 to 83	1024: Transformer overtemp. alarm
F4-03	DI4 function selection	0 to 83	1026: Cabinet door travel switch
F4-04	DI5 function selection	0 to 83	1027: Cabinet top fan state feedback
F4-05	DI6 function selection	0 to 83	1020: Local/Remote
F4-06	DI7 function selection	0 to 83	33: Control power normal
F4-07	DI8 function selection	0 to 83	0
F4-08	DI9 function selection	0 to 83	1: Forward run
F4-09	DI10 function selection	0 to 83	1003: Three-wire control mode
F4-10	DI11 function selection	0 to 83	9: Fault reset
F4-11	DI12 function selection	0 to 83	28: Remote 1/Remote 2
F4-12	DI13 function selection	0 to 83	58: Forward run 2
F4-13	DI14 function selection	0 to 83	1060: Three-wire control mode
F4-14	DI15 function selection	0 to 83	0
F4-15	DI16 function selection	0 to 83	0
F4-16	DI17 function selection	0 to 83	0
F4-17	DI18 function selection	0 to 83	0

These parameters are used to set the functions of the DI terminals, and the values of F4-00 to F4-06 must not be changed.

Note

The setting 1 of the thousand's digit indicates active when normally-open.

- If the setting value is 1001, it indicates that the AC drive runs in forward direction when the DI terminal is inactive.
- If the setting value is 1, it indicates that AC drive runs in forward direction when the DI terminal is active.

The functions of the digital input terminals are described in the following figure.

Value	Function	Description
0	No function	Set reserved terminals to 0 to avoid malfunction.
1	Forward run (FWD)	External DI terminals set for the two functions control forward and reverse running of the AC drive. It is applicable to remote 1 control.
2	Reverser run (REV)	
3	Three-wire control mode	It is applicable to remote 1 control. The DI terminal set for this function determines three-wire control mode of the AC drive. For details, see the description of F4-73.
4	Forward jog (FJOG)	FJOG indicates forward jog.
5	Reverse jog (RJOG)	RJOG indicates reverse jog .
6	Terminal UP	The terminals set for the two functions are used for increment and decrement when frequency reference is input via external DI terminal, or when the frequency source is digital setting.
7	Terminal DOWN	
8	Coast to stop	When the terminal set for this function becomes on, the AC drive shuts off output and the stop process of the motor is not controlled by the AC drive. It means the same as coast to stop described in F6-10.
9	Fault reset (RESET)	You can perform fault reset via DI terminal set for this function. It is the same as the function of the RESET key on the HMI. Remote fault reset is implemented by this function.
10	RUN disabled	When the terminal set for this function becomes on, the AC drive decelerates to stop and retains all running parameters, such as the PLC parameters, wobble and PID parameters. Once the terminal becomes off, the AC drive resumes the running state before stop.
11	External fault NO input	When the terminal set for this function becomes on, the AC drive reports F15.

Value	Function	Description
12	Multi-reference terminal 1	The 16 speeds or 16 other references can be implemented through combinations of 16 states of these four terminals.
13	Multi-reference terminal 2	
14	Multi-reference terminal 3	
15	Multi-reference terminal 4	
16	Terminal 1 for acceleration/ deceleration time selection	Totally four groups of acceleration/deceleration time can be selected through combinations of four states of these two terminals.
17	Terminal 2 for acceleration/ deceleration time selection	
18	Frequency reference setting channel switchover	The terminal set for this function is used to perform switchover between two frequency reference setting channels according to the setting in F0-07.
19	UP and DOWN setting clear (terminal, operation panel)	If the frequency reference setting channel is digital setting, the terminal set for this function is used to clear the modification by using the UP/DOWN function, restoring the frequency reference to the value of F0-08.
20	Local/Remote	This terminal is used to perform switchover between local control and remote control (F0-02). When the terminal becomes ON, local control (HMI) is prohibited, and the AC drive is in remote control mode.
21	Acceleration/Deceleration prohibited	This function ensures the AC drive to maintain the current frequency output without being affected by external signals (except the STOP command).
22	PID disabled	This function disables the PID function. The AC drive maintains the current frequency output without supporting the PID function.
23	PLC state reset	When the simple PLC function is enabled again after it was disabled in the execution process, this function restores the original state of simple PLC for the AC drive.
24	Transformer overtemp. alarm	If the terminal set for this function becomes ON, the temperature of phase-shifting transformer of the AC drive reaches the alarm threshold, and the AC drive reports alarm A87.
25	Transformer overtemp. fault	If the terminal set for this function becomes ON, the temperature of the phase-shifting transformer reaches the fault threshold, and the AC drive reports fault F57.
26	Cabinet door travel switch	If the terminal set for this function becomes ON, it indicates that the cabinet doors are not properly closed or the travel switch is faulty, and the AC drive reports fault F58.
27	Fan state feedback	If the terminal set for this function becomes ON, it indicates that the fan is not started properly after the MV power is applied, and the AC drive reports fault F59.

Value	Function	Description
28	Remote 1/Remote 2	The terminal set for this function performs switchover between remote 1 command source (F0-02) and remote 2 command source (F0-29). When the terminal becomes ON, remote 1 command source is prohibited, and the AC drive is in remote 2 control mode.
29	Torque control prohibited	Torque control is prohibited, and the AC drive enters the speed control mode.
30	Pulse input (valid only for DI18)	DI18 is used for pulse input.
31	Emergency stop	After the "Emergency stop" button is pressed, the system stops and enables the input MV breaker.
33	Control power normal	If this terminal becomes OFF, the AC drive reports fault F46 and stops.
34	Frequency modification enabled	When the terminal set for this function is OFF, the AC drive does not respond to frequency modification until the terminal becomes ON.
35	PID operation direction reverse	When the terminal set for this function becomes ON, the PID operation direction is reversed to the direction set in FA-03.
37	Emergency trip of medium voltage	When the terminal set for this function becomes ON, the system stops and trips the medium voltage.
38	PID integral disabled	When the terminal set for this function becomes ON, the integral function becomes disabled. However, the proportional and differentiation functions are still enabled.
39	Switchover between main frequency reference and preset frequency	When the terminal set for this function becomes ON, the frequency reference is replaced by the preset frequency set in F0-08.
40	Switchover between auxiliary frequency reference and preset frequency	When the terminal set for this function becomes ON, the frequency reference is replaced by the preset frequency set in F0-08.
41	Motor selection 1	The total of four groups of motor parameters can be switched over through combinations of four states of these two terminals.
42	Motor selection 2	
43	PID parameter switchover	The terminal set for this function performs switchover between groups of PID parameters. The PID parameters are FA-05 to FA-07 when the terminal set for this function becomes OFF.
44	User-defined fault 1	If the terminals set for these two functions become ON, the AC drive reports F27 and F28 respectively.
45	User-defined fault 2	
46	Speed control/Torque control	This function enables the AC drive to switch over between speed control and torque control.

Value	Function	Description
50	Bypass cabinet 1 cable inlet contactor/knife switch feedback	If the terminal set for this function is ON, it indicates that the upstream vacuum contactor of the AC drive bypass cabinet 1 has been closed.
51	Bypass cabinet 1 cable outlet contactor/knife switch feedback	If the terminal set for this function is ON, it indicates that the downstream vacuum contactor of the AC drive bypass cabinet 1 has been closed.
52	Bypass cabinet 1 line voltage contactor/knife switch feedback	If the terminal set for this function is ON, it indicates that the line voltage vacuum contactor of bypass cabinet 1 has been closed.
53	AC drive contactor feedback	If the terminal set for this function is ON, it indicates that the AC drive contactor for synchronous transfer has been closed.
54	Line voltage contactor feedback	If the terminal set for this function is ON, it indicates that the line voltage contactor for synchronous transfer has been closed.
56	Excitation cabinet ready	If the terminal set for this function is ON, it indicates that the excitation cabinet is ready.
57	Excitation cabinet faulty	If the terminal set for this function is ON, it indicates that the excitation cabinet is faulty and the AC drive reports F54.
58	Forward RUN 2 (FWD 2)	External DI terminals set for the two functions control forward and reverse running of the AC drive. It is applicable to remote 2 control
59	Reverse RUN 2 (REV 2)	
60	Three-wire control mode 2	It is applicable to remote 2 control. The DI terminal set for this function determines three-wire control mode of the AC drive. For details, see the description of F4-73.
61	Pre-charge command	If the terminal set for this function is ON, the AC drive pre-charge time sequence is executed. This function is applicable to the AC drive requiring pre-charge.
63	Cross-flow fan state feedback	If the terminal set for this function is ON, it indicates that the cross-flow fan should be in the working state.
66	Bypass cabinet 2 cable inlet contactor/knife switch feedback	If the terminal set for this function is ON, it indicates that the upstream vacuum contactor of the AC drive bypass cabinet 2 has been closed.
67	Bypass cabinet 2 cable outlet contactor/knife switch feedback	If the terminal set for this function is ON, it indicates that the downstream vacuum contactor of the AC drive bypass cabinet 2 has been closed.
68	Bypass cabinet 2 line voltage contactor/knife switch feedback	If the terminal set for this function is ON, it indicates that the line voltage vacuum contactor of bypass cabinet 2 has been closed.
69	Pre-charge contactor feedback	If the terminal set for this function is ON, it indicates that the pre-charge contactor has been closed.

Value	Function	Description
71	Process ready	If this function is selected and the terminal set for this function is OFF, the AC drive cannot run normally.
72	Water cooling system fault	If the terminal set for this function is ON, it indicates that the water cooling system is faulty and the AC drive reports F49 and enables the input MV breaker.
73	Cable inlet breaker feedback	If the terminal set for this function is ON, it indicates that the upstream cable inlet breaker of the AC drive has been closed.
74	Automatic up transfer	When the terminal set for this function becomes ON during the drive running, the AC drive automatically transfers the motor to line voltage control from AC drive control. The terminal must be connected to a switch.
75	Up transfer	when the terminal set for this function becomes ON during the drive running, the AC drive automatically transfers the motor to line voltage control from AC drive control. The terminal must be connected to a button.
76	Down transfer	When the terminal set for this function becomes ON during the motor running, the AC drive automatically transfers the motor to AC drive control from line voltage control.
78	AC drive contactor closing command	When the terminal set for this function becomes ON, the AC drive closes the AC drive contactor. It is applicable to the AC drive requiring synchronous transfer.
79	Reactor overtemp. fault	If the terminal set for this function is ON, it indicates that the overtemp. fault occurs on the reactor used for synchronous transfer and the AC stops synchronous transfer.
80	Reactor bypass contactor feedback	It is applicable to the AC drive with the synchronous transfer function and is used to judge whether the reactor bypass contactor is closed.
81	Pre-charge resistor bypass contactor feedback	It is applicable to the AC drive with the pre-charge resistor and is used to judge whether the pre-charge resistor bypass contactor is closed.
82	Excitation cabinet running feedback	It is used to receive the running state of the excitation cabinet. If the terminal set for this function is ON, it indicates that the bypass cabinet is in the running state. If the terminal is Off, it indicates that the bypass cabinet is in the stop state.
83	Bypass command	It is applicable to the automatic bypass cabinet. If the command is valid during the drive running, the AC drive automatically transfers the motor to line voltage.

The four multi-reference terminals have 16 state combinations, corresponding to 16 reference values. The first eight references are listed in the following table.

K4	K3	K2	K1	Reference Setting	Corresponding Pr.
OFF	OFF	OFF	OFF	Reference 0	FC-00
OFF	OFF	OFF	ON	Reference 1	FC-01
OFF	OFF	ON	OFF	Reference 2	FC-02
OFF	OFF	ON	ON	Reference 3	FC-03
OFF	ON	OFF	OFF	Reference 4	FC-04
OFF	ON	OFF	ON	Reference 5	FC-05
OFF	ON	ON	OFF	Reference 6	FC-06
OFF	ON	ON	ON	Reference 7	FC-07

If the frequency reference setting channel is multi-reference, the value 100% of FC-00 to FC-15 corresponds to the value of F0-10 (Maximum frequency).

Besides the multi-speed function, the multi-reference can be also used as the PID setting source, satisfying the requirement for switchover of different setting values.

Function Code	Parameter Name	Setting Range	Default
F4-66	Filter time of DI1 to DI8	0.000s to 1.000s	0.030s

It is used to set the software filter time of a DI terminal. If DI terminals are liable to interference, which may cause malfunction, increase the value of this parameter to enhance the anti-interference capability. However, increase of DI filter time will reduce the response of DI terminals.

Function Code	Parameter Name	Setting Range	Default
F4-67	DI9 delay	0.0–3600.0s	0.0s

It is used to set the delay of the AC drive when the status of DI9 changes.

Function Code	Parameter Name	Setting Range	Default
F4-71	DI16 replacement selection	0 to 7	0
F4-72	DI17 replacement selection	0 to 7	0

- When F4-71 is set to 0 or 1, the DI16 replacement function is disabled, and whether DI16 is valid based on DI16 level and the setting of F4-15.
- When F4-71 is set to a value between 2 and 7, DI16 replaces the corresponding terminal among DI2 to DI7, and whether the function of this corresponding terminal is enabled is determined by DI16 level.

For example, if F4-71 is set to 3, DI16 will replace DI3 and the original DI3 will take no effect. Whether the function of DI3 set in F4-02 is enabled is determined by DI16 level.

F4-72 is set in the same way as F4-71.

Function Code	Parameter Name	Setting Range	Default
F4-73	Terminal command mode	0: Two-wire mode 1 1: Two-wire mode 2 2: Three-wire mode 1 3: Three-wire mode 2 <hr/> Unit's digit: Terminal command channel 1 <hr/> Ten's digit: Terminal command channel 2	H.22

This parameter defines the four different modes of controlling the AC drive running via external DI terminals.

Note

Here takes DI9, DI10 and DI11 as the external DI terminals to control the AC drive running.

You can set the function of DI9, DI10 and DI11 by setting F4-08, F4-09 and F4-10, respectively. For details, see the descriptions of F4-08 to F4-17.

■ 0: Two-wire Control Mode 1

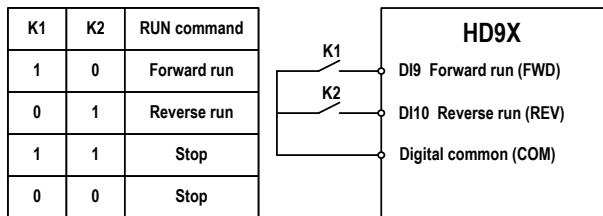
It is the most commonly used two-wire control mode. Allocate the DI9 with the forward run function and the DI10 with the reverse run function.

You need to connect the forward run switch to the DI9 terminal and the reverse run switch to the DI10 terminal.

The parameters are set as below:

Function Code	Parameter Name	Value	Function Description
F4-73	Terminal command mode	H.x0	Two-wire control mode 1
F4-08	DI9 function selection	1	Forward RUN (FWD)
F4-09	DI10 function selection	2	Reverse RUN (REV)

Figure 8-2 Two-wire control mode 1



In this mode,

- When K1 is closed, the motor rotates in the forward direction. When K1 is open, the motor stops.
- When K2 is closed, the motor rotates in the reverse direction. When K2 is open, the motor stops.
- When SW1 and SW2 are both open or closed simultaneously, the motor stops.

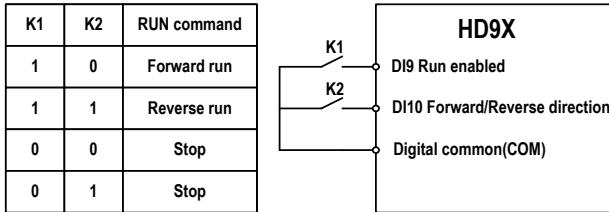
■ 0: Two-wire Control Mode 2

In this mode, DI9 is RUN enabled terminal, and DI10 determines the running direction.

The parameters are set as below:

Function Code	Parameter Name	Value	Function Description
F4-73	Terminal command mode	H.x1	Two-wire mode 2
F4-08	DI9 function selection	1	RUN enabled
F4-09	DI10 function selection	2	Forward or reverse direction

Figure 8-3 Two-wire control mode 2



In this mode,

When K1 is closed, the motor rotates in the forward direction after you keep K2 open.

When K2 is closed, the motor rotates in the reverse direction after you close K2.

When K1 is open, the motor stops no matter whether K2 is open or closed.

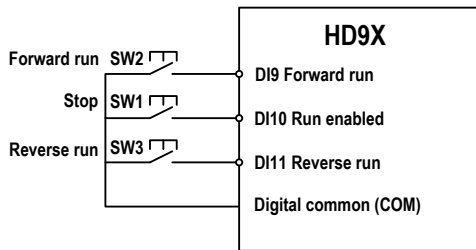
■ 2: Three-wire Control Mode 1

In this mode, DI10 is the RUN enabling terminal, and the direction is decided by DI9 and DI11.

The parameters are set as below:

Function Code	Parameter Name	Value	Function Description
F4-73	Terminal command mode	H.x2	Three-wire mode 1
F4-08	DI9 function selection	1	Forward RUN (FWD)
F4-09	DI10 function selection	1003	Three-wire control
F4-10	DI11 function selection	3	Reverse RUN (REV)

Figure 8-4 Three-wire control mode 1



In this mode,

- SW1 must remain open during the start sequence and during normal run operation.
- The motor stops immediately after SW1 closes.
- Signals from SW1 and SW2 are valid only after SW3 closes.
- On the condition that SW1 is closed, after you press down SW1, the motor rotates in the forward direction. After you press down SW2, the motor rotates in the reverse direction.

The running state of the AC drive is determined by the actions of the three buttons.

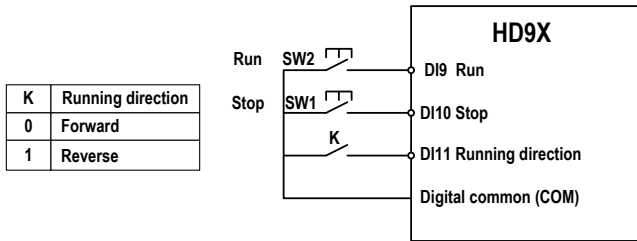
■ 3: Three-wire Control Mode 2

In this mode, DI10 is the RUN enabling terminal. The RUN command is given by DI9 and the direction is decided by DI11.

The parameters are set as below:

Function Code	Parameter Name	Value	Function Description
F4-73	Terminal command mode	H.22	Three-wire mode 2
F4-08	DI9 function selection	1	RUN command
F4-09	DI10 function selection	1003	Three-wire control
F4-10	DI11 function selection	2	Forward or reverse direction

Figure 8-5 Three-wire control mode 2



In this mode,

- SW1 must remain open during the start sequence and during normal run operation.
- The motor stops immediately after SW1 closes.
- Signals from SW2 are valid only at close edge action.
- On the condition that SW1 is closed and you press down SW1, the AC drive runs. If you keep K off, the motor rotates in the forward direction. After you turns K on, the motor rotates in the reverse direction.

Group F5: Output Terminals

The HD9X provides a total of 16 multi-functional DO terminals. If more DO terminals are required, use an extension I/O board or configure a PLC optional module.

Function Code	Parameter Name	Setting Range	Default
F5-01	DO2 function selection	0 to 83	1041: Input MV breaker enable
F5-02	DO3 function selection	0 to 83	40: MV switch-on allowed
F5-03	DO4 function selection	0 to 83	44: Main power indication
F5-04	DO5 function selection	0 to 83	15: Ready
F5-05	DO6 function selection	0 to 83	1: Drive running
F5-06	DO7 function selection	0 to 83	1001: Drive in stop
F5-07	DO8 function selection	0 to 83	2: Fault output
F5-08	DO9 function selection	0 to 83	45: Alarm output
F5-09	DI10 function selection	0 to 83	46: HMI reset
F5-10	DI11 function selection	0 to 83	0
F5-11	DI12 function selection	0 to 83	0
F5-12	DI13 function selection	0 to 83	0
F5-13	DI14 function selection	0 to 83	0
F5-14	DI15 function selection	0 to 83	0
F5-15	DI16 function selection	0 to 83	0
F5-16	DI17 function selection	0 to 83	0

The functions of the digital output terminals are described in the following figure.

Value	Function	Description
0	No function	The terminal has no function.
1	AC drive running	When the AC drive is running and has output frequency (can be zero), the terminal set for this function becomes ON.
2	Fault output (stop)	When the AC drive stops due to the occurrence of a fault, the terminal set for this function becomes ON.
5	Zero-speed running	If the AC drive runs with the output frequency of 0, the terminal set for this function becomes ON. If the AC the terminal set for this function becomes OFF.
6	Motor overload pending	The AC drive judges whether the motor load exceeds the overload pending threshold before performing the protection action. If the pending threshold is exceeded, the terminal set for this function becomes ON.
7	AC drive overload pending	This terminal becomes ON 10s before the AC drive performs the overload protection action.
11	PLC cycle complete	When simple PLC completes one cycle, the terminal outputs a pulse signal with width of 250 ms.

Value	Function	Description
12	Accumulative running time reached	When the accumulative running time of the AC drive reaches the setting threshold, the terminal set for this function becomes ON.
14	Torque limited	In speed control mode, if the output torque reaches the torque limit, the AC drive enters the stall protection state and meanwhile the terminal set for this function becomes ON.
15	Ready for RUN	After the MV power is applied properly, cell self-check is complete and the AC drive does not detect any fault, the AC drive is ready for running and the terminal set for this function becomes ON.
16	AI1 > AI2	When the input of AI1 is larger than the input of AI2, the terminal set for this function becomes ON.
17	Frequency upper limit reached	If the running frequency and the target frequency reach or are above the frequency upper limit, the terminal set for this function becomes ON.
18	Frequency lower limit reached (no output at stop)	If the running frequency and the target frequency reach or are below the lower limit, the terminal set for this function becomes ON. In the stop state, the terminal is OFF.
23	Zero-speed output	If the output frequency of the AC drive is 0, the terminal set for this function becomes ON. In the stop state, the terminal is still ON.
24	Accumulative power-on time reached	When the accumulative power-on time of the AC drive reaches the setting threshold, the terminal set for this function becomes ON.
40	MV switch-on allowed	After the control system is powered on, the terminal set for this function becomes ON when the following requirements are satisfied: The emergency stop signal is invalid The undervoltage fault or no fault exists. The MV switch-off time exceeds the setting of F8-58 (Delay of MV switch-on allowed) The fan dehumidification function is enabled and the time exceeds the setting of F8-60 (Dehumidification time)

Value	Function	Description
41	Input MV breaker enable	<p>This terminal becomes ON when any of the following conditions occurs:</p> <ul style="list-style-type: none"> • The emergency input is active. • The input current of the transformer is too large (F35). • The input current is unbalanced (F36). • The input medium voltage exceeds the limit (F37). • The control power is faulty (F46). • The water-cooling system is faulty (F49). • Overtemp. fault occurs on the phase-shifting transformer (F57). • The travel switch of the cabinet door is not in place (F58). • The cooling fan is faulty (F59). • The input voltage is abnormal (F160). <p>Note: When the fault (F35, F36, F37, F46, F49, F57, F58, F59 or F160) occurs and the bypass cabinet 1 line-voltage contactor opens, the terminal set for this function becomes ON.</p>
42	AC drive running contactor output	When the system reports motor overvoltage or detects the excitation cabinet fault, the terminal set for this function becomes OFF.
44	Main power indication	When the input voltage reaches one sixteenth of the primary-side rated voltage of the phase-shifting transformer, the terminal set for this function becomes ON.
45	Alarm output	When any alarm occurs, the terminal set for this function becomes ON.
46	HMI reset	When communication interruption between the HMI and the control board lasts 40s, the terminal set for this function becomes ON.
47	Bypass cabinet cable outlet contactor open	For the automatic bypass cabinet, on the condition that the bypass cabinet cable outlet contactor opens, if a fault occurs on the AC drive or the emergency stop signal is active, the terminal set for this function becomes ON.
49	Excitation command output	This function is used to control running of the excitation cabinet.
52	AC drive contactor close	When the down transfer starts, it is used to close the AC drive contactor.
53	AC drive contactor open	When up transfer is complete, it is used to open the AC drive contactor.
54	Line-voltage contactor close	When up transfer is complete, it is used to close the line-voltage contactor.
55	Line-voltage contactor open	When down transfer is complete, it is used to open the line-voltage contactor.
58	Power controller run command	During power controller pre-charge, this function is used to output the run command to the power controller.

Value	Function	Description
59	Power controller contactor control	During power controller pre-charge, this function is used to release or apply the power controller contactor.
60	Pre-charge contactor close	After the system pre-charge is complete, this function is used to close the AC drive upstream vacuum contactor.
61	Motor 1 automatic transfer to line voltage	For the bypass cabinet 1, when the bypass cabinet 1 cable outlet contactor closes, the MV power is normal and the AC drive is in running state, the bypass cabinet 1 cable outlet contactor opens first when a fault occurs. This moment when the automatic bypass delay is reached, the terminal set for this function becomes ON.
62	Fan automatic running	When the fan automatic running function is enabled or the MV power is applied, the terminal with this function becomes ON to start the fan. If this function is disabled and the MV power is switched off, this terminal becomes OFF after a delay (F9-71) to stop the fan.
63	Pre-charge contactor open	After system pre-charge is complete, this function is used to open the upstream contactor of the AC drive.
64	MV breaker enable of switch cabinet 2	This terminal becomes ON when any of the following conditions occurs: <ul style="list-style-type: none"> • The emergency input is active. • The MV breaker enable function is enabled and the bypass cabinet 2 line-voltage contactor opens.
65	Motor 2 automatic transfer to line voltage	For the bypass cabinet 2, when the bypass cabinet 2 cable outlet contactor closes, the MV power is normal and the AC drive is in running state, the bypass cabinet 2 cable outlet contactor opens first when a fault occurs. This moment when the automatic bypass delay is reached, the terminal set for this function becomes ON.
66	Motor 1 in AC drive control indication	When motor 1 is controlled by the AC drive, the terminal set for this function becomes ON.
67	Motor 1 in line voltage control indication	When motor 1 is controlled by the line voltage, the terminal set for this function becomes ON.
68	Up transfer ready	When the motor runs normally under the control of the AC drive, the terminal set for this function becomes ON.
69	Down transfer ready	When the motor is under the control of the line voltage and the AC drive is in the state of ready to run, the terminal set for this function becomes ON.
70	Synchronous transfer contactor unlock	During the synchronous transfer, this function is used to unlock the interlock control of the line-voltage contactor and the AC drive contactor.
71	Up transfer indication	When the motor is in the up transfer process, the terminal set for this function becomes ON.
72	Down transfer indication	When the motor is in the down transfer process, the terminal set for this function becomes ON.

Value	Function	Description
75	Heater start	It is used together with the dehumidification function. The heater starts automatically once the fan is switched on and stops after the dehumidification is complete.
76	Pre-charge resistor bypass contactor open	It is applicable to the AC drive with the pre-charge resistor. The terminal set for this terminal becomes ON when any of the following conditions occurs: <ul style="list-style-type: none"> • The input of MV breaker enable is active. • The system reports pre-charge fault. • The external device gives the pre-charge open signal. • The medium voltage of the AC drive is switched off.
77	Pre-charge resistor bypass contactor close	It is applicable to the AC drive with the pre-charge resistor. After pre-charging is complete, it is used for the bypass pre-charge resistor.
78	Reactor bypass contactor open	It is applicable to the synchronous transfer. This signal is active when the synchronous transfer command is valid.
79	Reactor bypass contactor close	It is applicable to the synchronous transfer. This signal is active when the synchronous transfer command is invalid.
80	Motor 2 in AC drive control indication	It is applicable to the bypass cabinet in the scenario where one AC drive can drive two motors. When the motor 2 is controlled by the AC drive, the terminal set for this function becomes ON.
81	Motor 2 in line voltage control indication	It is applicable to the bypass cabinet in the scenario where one AC drive can drive two motors. When the motor 2 is controlled by the Aline voltage, the terminal set for this function becomes ON. The indication is displayed on the bypass cabinet 2.
82	Remote 1/Remote 2	It is used to indicate whether the AC drive is controlled by remote 1 or remote 2.
83	Switch cabinet 2 switch-on allowed	It is applicable to the bypass cabinet in the scenario where one AC drive can drive two motors. When the emergency stop is invalid, there is no fault, the dehumidification is complete and the switch-on relay is reached, this signal is active.
84	Designated fault output	It is used together with F8-65 (designated fault output SN). If the fault SN of the AC drive is consistent with the setting of F8-65, this signal is active.

Function Code	Parameter Name	Setting Range	Default
F5-69	DO12 delay	0.0s to 3600.0s	0.0s

It is used to set the delay of the AC drive when the status of DO12 changes.

Group F6: Start/Stop Control

Function Code	Parameter Name	Setting Range	Default
F6-00	DI9 delay	0: Direct start 1: Catching a spinning motor in the forward direction 2: Catching a spinning motor in the reverse direction 3: Catching a spinning motor in the forward/reverse direction	0

The catching a spinning motor function allows the AC drive to detect the speed of the running motor and output the voltage corresponding to the motor frequency, minimizing the impact of applying power to the motor. When catching the spinning motor, the AC drive monitors the motor magnetic flux and starts the motor at the current motor frequency.

You can set the direction of catching a spinning motor in this parameter. If the motor rotating direction is known, set this parameter to 1 or 2 according to the actual direction. If the motor rotating direction is unknown, set this parameter to 3.

- 0: Direct start

The AC drive starts from zero frequency.

- 1: Catching a spinning motor in the forward direction

The AC drive detects the motor speed in the forward direction and then starts at the detected motor frequency, implementing smooth start without impacting the rotating motor.

- 2: Catching a spinning motor in the forward direction

The AC drive detects the motor speed in the reverse direction and then starts at the detected motor frequency, implementing smooth start without impacting the rotating motor.

- 3: Catching a spinning motor in the forward/reverse direction

The AC drive detects the motor speed in the forward direction first. If the detection fails, the AC drive performs detection in the reverse direction. Then, the AC drive starts at the detected motor frequency, implementing smooth start without impacting the rotating motor.

Function Code	Parameter Name	Setting Range	Default
F6-10	Stop mode	0: Decelerate to stop 1: Coast to stop	1

- 0: Decelerate to stop

After the stop command is active, the AC drive decreases the output frequency based on the deceleration time and stops when the frequency decreases to zero.

- 1: Coast to stop

After the stop command is active, the AC drive immediately stops the output. The motor will coast to stop based on the mechanical inertia.

Function Code	Parameter Name	Setting Range	Default
F6-16	Current of catching a spinning motor	1.0% to 50.0%	20.0%

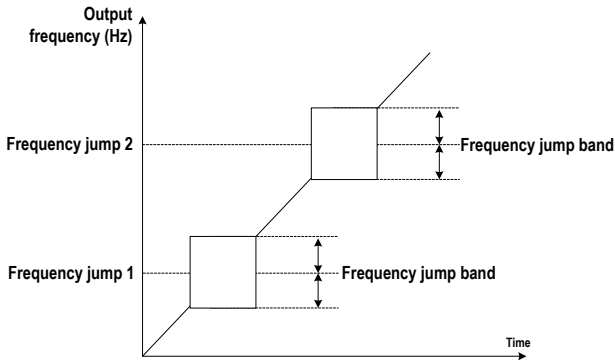
It is used to set the current for frequency scanning at catching a spinning motor.

Group F8: Auxiliary Functions

Function Code	Parameter Name	Setting Range	Default
F8-09	Frequency jump 1	0.00 Hz to max. frequency	0.00 Hz
F8-10	Frequency jump 2	0.00 Hz to max. frequency	0.00 Hz
F8-11	Frequency jump band	0.00 Hz to max. frequency	0.00 Hz

The frequency jump function enables the AC drive to avoid the mechanical resonance point of the load. The HD9X can be set with two separate frequencies. If both are set to 0, the frequency jump function is disabled.

Figure 8-6 The frequency jump function



Function Code	Parameter Name	Setting Range	Default
F8-13	Reverse control	0: Enabled 1: Disabled	0.00 Hz

This function parameter determines whether reverse RUN is allowed. In the applications where reverse RUN is prohibited, set this parameter to 1.

Function Code	Parameter Name	Setting Range	Default
F8-18	Start protection selection	0: Disabled 1: Enabled	0.00 Hz

This function parameter determines whether to enable safety protection at drive startup. If such protection is enabled (F8-18 = 1), the AC drive will not respond to the RUN command that is input at power-on or fault reset. This helps to avoid the danger caused by unexpected motor running at power-on or fault reset.

The AC drive will get out of start protection after you cancel the RUN command.

Function Code	Parameter Name	Setting Range	Default
F8-53	Auxiliary function selection	0 to FFFF	H.0001

It is used to select the auxiliary functions of the AC drive, meeting requirements of various applications. The setting is as follows:

Bit	Meaning of Value	
	0	1
Bit4	Stopping if there is no RUN command after fault reset	Keeping the AC drive state before the fault occurrence after fault reset (active when the command source is three-wire control mode or communication)
Bit7	Reporting fault F47 if power of the I/O board is abnormal	Not reporting fault F47 if power of the I/O board is abnormal

The other bits are reserved.

Function Code	Parameter Name	Setting Range	Default
F8-57	Auxiliary function selection 2	0 to H.FF12	H.0000

The setting is as follows:

Other Digits	Ten's digit	Unit's digit
Reserved	0: No extension PLC	0: No bypass cabinet
	1: With extension PLC	1: Manual bypass cabinet
		2: Automatic bypass cabinet

Group F9: Protections

Function Code	Parameter Name	Setting Range	Default
F9-03	Motor overload protection threshold	10.0% to 220.0%	120.0%

The value 100.0% corresponds to the rated motor current. When the motor current exceeds the rated motor current x F9-00 and the time lasts one minute, the AC drive reports the motor overload fault.

Function Code	Parameter Name	Setting Range	Default
F9-06	Motor overvoltage protection threshold	0.0% to 200.0%	125.0%

This parameter sets the motor overvoltage protection threshold to avoid too high back EMF. The value 100.0% corresponds to the rated motor voltage.

Function Code	Parameter Name	Setting Range	Default
F9-09	Fault auto reset times	0 to 20	0

This parameter sets the times of fault auto reset. After the value is exceeded, the AC drive will remain in the faulty state.

Function Code	Parameter Name	Setting Range	Default
F9-11	Time interval of fault auto reset	0.1s to 100.0s	2.0s

This parameter sets the waiting time from the alarm of the AC drive to fault auto reset.

Function Code	Parameter Name	Setting Range	Default
F9-30	AC drive overcurrent protection threshold	0.0%–180.0%	150.0%

During the drive running, if the instantaneous output current > Rated output current of AC drive x F9-30, the AC drive reports the overcurrent fault. The value 100.0% corresponds to the rated output current of the AC drive.

Function Code	Parameter Name	Setting Range	Default
F9-31	AC drive maximum output current	0.0% to F9-30 - 20.0%	120.0%

This parameter sets the maximum output current during the drive normal running.

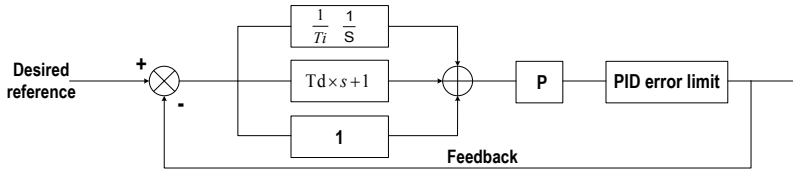
The setting of F9-31 is related to F9-30. When the setting of F9-30 is equal to or smaller than 20.0%, the setting range of F9-31 is 0.0% to 180.0%. When the setting of F9-30 is larger than 20.0%, the setting range of F9-31 is 0.0% to F9-30 - 20.0%.

The value 100.0% corresponds to the rated output current of the AC drive.

Group FA: PID Function

The PID (Proportional + Integral + Derivative) function uses system feedback for closed-loop control of variables such as flow, pressure, temperature, and so on. The purpose of the PID control is to keep the drive output frequency as close as possible to a desired reference via the PID adjustment.

Figure 8-7 The PID function schematic diagram



Function Code	Parameter Name	Setting Range	Default
FA-00	PID reference source	0: FA-01	0
		1: AI1	
		2: AI2	
		3: AI3	
		4: Pulse setting (DI18)	
		5: Communication setting	
		6: Multi-reference	
		7: AI4	
FA-01	PID digital setting	0.0% to 100.0%	50.0%

FA-00 is used to select the setting channel of the PID reference.

The PID setting is a relative value and ranges from 0.0% to 100.0%. The PID feedback is also a relative value. The purpose of PID control is to make the PID feedback as close as possible to the PID reference.

Function Code	Parameter Name	Setting Range	Default
FA-02	PID feedback source	0: AI1 1: AI2 2: AI3 3: AI1 - AI2 4: Pulse setting (DI5) 5: Communication setting 6: AI1 + AI2 7: Maximum (AI1 , AI2) 8: Minimum (AI1 , AI2) 9: AI4	0

This parameter selects the feedback signal channel of process PID. The PID feedback is a relative value and ranges from 0.0% to 100.0%.

Function Code	Parameter Name	Setting Range	Default
FA-05	Proportional gain Kp1	0.0 to 100.0	20.0
FA-06	Integral time Ti1	0.01s to 10.00s	2.00s
FA-07	Differential time Td1	0.00s to 10.000s	0.000s

These function parameters are the proportional gain (Kp1), integral time (Ti1) and derivative time (Td1) of PID control.

- Proportional gain (Kp1)
A large value tends to reduce the present error, but too large setting will cause system oscillation.
- Integral time (Ti1)
The shorter the integral time is, the faster the error will be predicted. But too short setting will cause overshoot or system oscillation.
- Derivative time (Td1)
The longer the derivative time is, the faster the system will respond to the error. But too longer setting will cause vibration.

Group Fb: Fault Records

Function Code	Parameter Name	Setting Range
Fb-00	6th fault type	0 to 199
Fb-01	7th fault type	
Fb-02	8th fault type	
Fb-03	9th fault type	
Fb-04	10th (latest) fault type	

These parameters record the type of the latest five faults of AC drive. The value 0 indicates that there is no fault. For probable causes and solution of each fault, refer to Chapter 9.

Function Code	Parameter Name	Description
Fb-05	Frequency upon 10th (latest) fault	Frequency at fault occurrence
Fb-06	Output current upon 10th (latest) fault	Output current at fault occurrence
Fb-07	Output voltage upon 10th (latest) fault	Output voltage at fault occurrence
Fb-08	Input current upon 10th (latest) fault	Input current at fault occurrence
Fb-09	Input voltage upon 10th (latest) fault	Input voltage at fault occurrence
Fb-10	AC drive state upon 10th (latest) fault	Drive running state at fault occurrence
Fb-11	Fault prompt of 10th (latest) fault	Fault prompt at fault occurrence
Fb-15	Frequency upon 9th (latest) fault	The same as that of Fb-05 to Fb-11
Fb-16	Output current upon 9th (latest) fault	
Fb-17	Output voltage upon 9th (latest) fault	
Fb-18	Input current upon 9th (latest) fault	
Fb-19	Input voltage upon 9th (latest) fault	
Fb-20	AC drive state upon 9th (latest) fault	
Fb-21	Fault prompt of 9th (latest) fault	
Fb-25	Frequency upon 8th (latest) fault	The same as that of Fb-05 to Fb-11
Fb-26	Output current upon 8th (latest) fault	
Fb-27	Output voltage upon 8th (latest) fault	
Fb-28	Input current upon 8th (latest) fault	
Fb-29	Input voltage upon 8th (latest) fault	
Fb-30	AC drive state upon 8th (latest) fault	
Fb-31	Fault prompt of 8th (latest) fault	

Function Code	Parameter Name	Description
Fb-35	Frequency upon 7th (latest) fault	The same as that of Fb-05 to Fb-11
Fb-36	Output current upon 7th (latest) fault	
Fb-37	Output voltage upon 7th (latest) fault	
Fb-38	Input current upon 7th (latest) fault	
Fb-39	Input voltage upon 7th (latest) fault	
Fb-40	AC drive state upon 7th (latest) fault	
Fb-41	Fault prompt of 7th (latest) fault	
Fb-45	Frequency upon 6th (latest) fault	The same as that of Fb-05 to Fb-11
Fb-46	Output current upon 6th (latest) fault	
Fb-47	Output voltage upon 6th (latest) fault	
Fb-48	Input current upon 6th (latest) fault	
Fb-49	Input voltage upon 6th (latest) fault	
Fb-50	AC drive state upon 6th (latest) fault	
Fb-51	Fault prompt of 6th (latest) fault	
Fb-55	5th fault type	0 to 199
Fb-57	4th fault type	
Fb-59	3th fault type	
Fb-61	2nd fault type	
Fb-63	1st fault type	

Group FC: Multi-Reference and Simple PLC Function

The multi-reference of the HD9X can be used as multi-speed and PID reference source. It is a relative value and ranges from -100.0% to 100.0%.

The simple PLC function is completely different from the user programmable function. It can only complete simple combination of multi-reference.

Function Code	Parameter Name	Setting Range	Default
FC-00	Reference 0	-100.0% to 100.0%	0.0%
FC-01	Reference 1	-100.0% to 100.0%	0.0%
FC-02	Reference 2	-100.0% to 100.0%	0.0%
FC-03	Reference 3	-100.0% to 100.0%	0.0%
FC-04	Reference 4	-100.0% to 100.0%	0.0%
FC-05	Reference 5	-100.0% to 100.0%	0.0%
FC-06	Reference 6	-100.0% to 100.0%	0.0%
FC-07	Reference 7	-100.0% to 100.0%	0.0%

As the frequency reference setting channel, it is a percentage relative to the maximum frequency. As the PID reference source, it does not require conversion.

Multi-reference can be switched over based on different states of DI terminals. For details, see the descriptions of group F4.

Group Fd: Communication

Function Code	Parameter Name	Setting Range	Default
Fd-00	Baud rate	0: 300 bps 1: 600 bps 2: 1200 bps 3: 2400 bps 4: 4800 bps 5: 9600 bps 6: 19200 bps 7: 38400 bps 8: 57600 bps 9: 115200 bps <hr/> Unit's digit: Modbus-RTU <hr/> Ten's digit: Reserved <hr/> Hundred's digit: Reserved <hr/> Thousand's digit: CANlink	H.5005

This parameter sets the data transmission rate between the host computer and the AC drive. Note that the baud rate of the host computer must be the same as that of the AC drive. Otherwise, communication shall fail. The higher the baud rate is, faster the communication will be

Function Code	Parameter Name	Setting Range	Default
Fd-01	Data format symbol	0: No check (8-N-2) 1: Even parity check (8-E-1) 2: Odd parity check (8-O-1) 3: 8-N-1	0

This parameter sets the data format between the host computer and the AC drive. The setting on the host computer must be the same as that on the AC drive; otherwise, communication shall fail.

Function Code	Parameter Name	Setting Range	Default
Fd-02	Local address	1 to 247 0: Broadcast address	1

When the local address is set to 0 (that is, the broadcast address), implementing the broadcast function of the host computer.

This address is unique (except the broadcast address), which is the basis for point-to-point communication between the host computer and the AC drive.

Function Code	Parameter Name	Setting Range	Default
Fd-03	Response delay	0 to 20 ms	2 ms

This parameter sets the delay from the time when AC drive receives the frame matching the local address to the time when the AC drive starts returning a response frame. If the response delay is shorter than the system processing time, the system processing time shall prevail. If the response delay is longer than the system processing time, the system sends data to the host computer only after the response delay time is reached.

Function Code	Parameter Name	Setting Range	Default
Fd-04	Communication timeout	0.0s: Invalid 0.1s to 60.0s	0.0s

When it is set to 0.0s, this parameter is invalid.

If this parameter is set to a non-zero value, when the AC drive does not receive the communication signal within the time set in this parameter, it will report the communication timeout fault (F16). Generally, this parameter is set to 0.0s. In applications with continuous communication, you can use this parameter to monitor the communication status.

Function Code	Parameter Name	Setting Range	Default
Fd-05	Data transmission format selection	Unit's digit: Modbus-RTU 0: Non-standard Modbus-RTU protocol 1: Standard Modbus-RTU protocol	1

When the unit's digit is set to 1, the standard Modbus protocol is used; when the unit's digit is set to 0, the slave returns a more byte than in the standard Modbus protocol at the read command. For details, see the HD9X Modbus Communication Protocol.

Group A6: AI Curve and Pulse Parameters

Function Code	Parameter Name	Setting Range	Default
A6-00	AI curve 1 minimum input	0.00 mA to A6-02	4.00 mA
A6-01	Corresponding percentage of AI curve 1 minimum input	-100.00% to 100.0%	0.0%
A6-02	AI curve 1 maximum input	A6-00 to 20.00 mA	20.00 mA
A6-03	Corresponding percentage of AI curve 1 maximum input	-100.00% to 100.0%	100.0%
A6-04	AI1 filter time	0.00s to 10.00s	0.10s

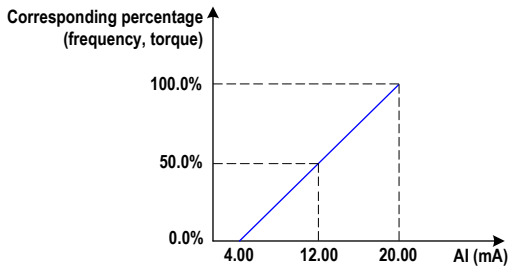
These parameters define the relationship between the analog input current and the corresponding percentage.

When the analog input current is larger the maximum value (A6-02), the maximum value is used. When the analog input current is less than the minimum value (A6-00), the minimum value or 0.0% is used.

A6-04 (AI1 filter time) is used to set the software filter time of AI1. If the analog input is liable to interference, increase the AI1 filter time to stabilize the detected analog. However, increase of the AI filter time will slow the response of analog detection. Set this parameter properly based on actual conditions.

In different applications, 100.0% of analog input corresponds to different nominal values. For details, refer to the description of different applications. The following figure shows a typical setting example.

Figure 8-8 Relationship between analog input and corresponding percentage



Function Code	Parameter Name	Setting Range	Default
A6-09	AI2 filter time	0.00s to 10.00s	0.10s

AI2 filter time is used to set the software filter time of AI2. If the analog input is liable to interference, increase the value of this parameter to stabilize the detected analog input. However, increase of the AI filter time will slow the response of analog detection. Set this parameter properly based on actual conditions.

Function Code	Parameter Name	Default
A6-52	AO1 function selection	0
A6-53	AO2 function selection	2
A6-54	AO3 function selection	0
A6-55	AO4 function selection	0
A6-56	AO5 function selection	0

The output range of AO1 to AO5 is 4 to 20 mA.

The relationship between pulse output range or analog output range and corresponding functions is listed in the following table.

Value	Function	Function Corresponding to Analog Output 0.0% to 100.0%)
0	Running frequency	0 to max. output frequency
1	Target frequency	0 to max. output frequency
2	Output current	0 to 2 times of rated motor current
3	Output torque	0 to 2 times of rated motor torque
4	Output power	0 to 2 times of rated power
5	Output voltage	0 to 1.2 times of rated AC drive voltage
6	Pulse input	0.01 to 50.0 kHz
7	AI1	4.00 to 20.00 mA
8	AI2	4.00 to 20.00 mA
9	AI3	4.00 to 20.00 mA
10	AI4	4.00 to 20.00 mA
12	Communication setting	0.0% to 100.0%
13	Motor speed	0 to motor speed corresponding to maximum output frequency
16	Excitation current	0 to 2 times of rated motor current
17	Input voltage	0 to 2 times of rated AC drive input voltage
18	Input current	0 to 2 times of rated AC drive input current

Function Code	Parameter Name	Setting Range	Default
A6-61	AO1 zero offset coefficient	-100.0% to 100.0%	20.0%
A6-62	AO1 gain	-100.0% to 100.0%	0.8
A6-63	AO2 zero offset coefficient	-100.0% to 100.0%	20.0%
A6-64	AO2 gain	-100.0% to 100.0%	0.8
A6-65	AO3 zero offset coefficient	-100.0% to 100.0%	20.0%
A6-66	AO3 gain	-100.0% to 100.0%	0.8
A6-67	AO4 zero offset coefficient	-100.0% to 100.0%	20.0%
A6-68	AO4 gain	-100.0% to 100.0%	0.8
A6-69	AO5 zero offset coefficient	-100.0% to 100.0%	20.0%
A6-70	AO5 gain	-100.0% to 100.0%	0.8

These parameters correct the offset of the analog output zero drift and the output amplitude. They can also be used to define the required AO curve.

If "b" represents zero offset, "k" represents gain, "Y" represents the actual output, and "X" represents the standard output, the actual output is: $Y = kX + b$.

The zero offset coefficient 100% of AO1 to AO5 corresponds 20 mA. The standard output refers to the value corresponding to the analog output of 0 to 20 mA with no zero offset or gain adjustment.



Trouble-shooting

Chapter 9 Troubleshooting

The HD9X provides the alarm and fault functions. When a fault occurs on the AC drive, the system indicates the fault information clearly and performs protections based on the fault/alarm grade, such as stopping, bypassing the faulty power cell, or even cutting off the medium-voltage input.

The HMI displays the specific fault/alarm, possible causes and corresponding solutions. You can determine the fault type, analyze the cause and perform troubleshooting based on the display of the HMI. If you need to seek technical support, contact Inovance.

The system performs protection and stops output once a fault occurs. If the fault disappears, the fault indicator becomes OFF but the fault information is recorded. The AC drive can be re-started only after the fault is rectified and the system is reset by pressing the "Reset" button. When a critical fault occurs, the MV breaker is enabled automatically. If the MV breaker is not enabled due to other reasons, press the Emergency stop button on the control cabinet.

9.1 System Alarms

A11	Motor overload
Possible causes	<ol style="list-style-type: none"> 1. Check whether the motor overload protective parameters (F9-01 to F9-03) are set improperly. 2. Check whether the load is too heavy or locked-rotor occurs on the motor. 3. The motor is abnormal. 4. The sampling of three-phase output voltage is abnormal. 5. The control hardware is abnormal.
Solutions	<ol style="list-style-type: none"> 1. Set F9-01 to F9-03 properly. 2. Reduce the load and check the motor and mechanical conditions. 3. Check whether the motor is abnormal and the three-phase winding insulation is normal. 4. Locked-rotor occurs on the motor or the output current reaches the setting upper limit. Check whether the three-phase output voltage sampling board is normal and whether the three-phase output voltage sampling circuit is normal. 5. Replace the I/O board or the main control board.

A12	Power input phase loss
Possible causes	<ol style="list-style-type: none"> 1. The three-phase input power is abnormal. 2. The three-phase input voltage sampling board is abnormal. 3. The input voltage sampling circuit of the AC drive is abnormal. 4. The control hardware is abnormal.
Solutions	<ol style="list-style-type: none"> 1. Eliminate external faults. 2. Check whether the three-phase input voltage sampling board is normal, whether the resistance value of the sampling board is correct, whether the phase sequence is correct, and whether the R, S, T cables of the AC drive are connected properly. 3. Eliminate the fault on the three-phase input voltage sampling circuit. 4. Replace the I/O board or the main control board. Contact Inovance for technical support.
A13	Power output phase loss
Possible causes	<ol style="list-style-type: none"> 1. The cable connecting the AC drive and the motor is abnormal. 2. The outputs of the AC drive are not connected to the motor. 3. The output current sampling circuit of the AC drive is abnormal. 4. The control hardware is abnormal.
Solutions	<ol style="list-style-type: none"> 1. Eliminate external faults. 2. Connect the outputs of the AC drive to the motor. 3. Check whether the output current sampling circuit is normal. 4. Replace the I/O board or the main control board.
A15	External alarm
Possible causes	The external fault signal is input through a multi-functional DI terminal.
Solutions	Reset the operation
A16	Communication alarm
Possible causes	<ol style="list-style-type: none"> 1. The customer's RS485/CAN interface is abnormal. 2. The communication cable is damaged. 3. The communication parameters in group Fd are set incorrectly.
Solutions	<ol style="list-style-type: none"> 1. Check whether the customer's RS485/CAN interface works properly. 2. Check the communication cable. 3. Set the communication parameters correctly.

A20	Encoder alarm
Possible causes	<ol style="list-style-type: none"> 1. The parameters in group F1 are set incorrectly. 2. The cable connection between the encoder and the PG card is abnormal. 3. The PG card is abnormal 4. The 24 V and 15 V switching-mode power supply is abnormal. 5. The encoder is abnormal 6. The main control board is abnormal.
Solutions	<ol style="list-style-type: none"> 1. Set the parameters in group F1 correctly. 2. Connect the cable between the encoder and the PG card properly and check whether cable connection breaks or is virtual according to the encoder instructions. 3. Check whether the cables of the MF38PG5 card are in good contact and whether the cables are connected properly. 4. Check whether the 24 V and 15 V switching-mode power supply. If abnormal, replace the I/O board 5. Replace the encoder. 6. Replace the I/O board or the main control board.
A27	User-defined alarm 1
Possible causes	<ol style="list-style-type: none"> 1. The user-defined alarm 1 signal is input through a multi-functional DI terminal. 2. The I/O board is abnormal.
Solutions	<ol style="list-style-type: none"> 1. Reset the operation. 2. Use another DI terminal or Replace the I/O board.
A28	User-defined alarm 2
Possible causes	<ol style="list-style-type: none"> 1. The user-defined alarm 2 signal is input through a multi-functional DI terminal. 2. The I/O board is abnormal.
Solutions	<ol style="list-style-type: none"> 1. Reset the operation. 2. Use another DI terminal or Replace the I/O board.
A29	Accumulative power-on time reached
Possible causes	Contact Inovance for technical support.
Solutions	Contact Inovance for technical support.
A30	Load lost
Possible causes	<ol style="list-style-type: none"> 1. The load is disconnected during the drive running. 2. The control hardware is abnormal.
Solutions	<ol style="list-style-type: none"> 1. Check whether the load is disconnected during the drive running, and check whether the setting of F9-64 and F9-65 satisfies the operating condition. 2. Replace the I/O board or the main control board.

A31	PID feedback lost during the drive running
Possible causes	The PID feedback is smaller than the setting of FA-26
Solutions	Check the PID feedback signal or set FA-26 properly.
A36	Input current unbalanced
Possible causes	<ol style="list-style-type: none"> 1. The input current detection circuit is abnormal. 2. The input current sampling mutual inductors are abnormal. 3. The input side of the transformer is abnormal. 4. The control hardware is abnormal.
Solutions	<ol style="list-style-type: none"> 1. Check the input current detection circuit. Check whether the connection breaks or whether the connection is virtual. 2. Check the two levels of mutual inductors are installed properly and eliminate the faults. 3. Contact Inovance for technical support. 4. Replace the I/O board or the main control board.
A39	PLC communication abnormal
Possible causes	<ol style="list-style-type: none"> 1. The PLC is not powered on. 2. The PLC does not run. 3. The communication circuit between the PLC and the main control board is abnormal. 4. The PLC is not configured but detecting whether the PLC is normal is enabled.
Solutions	<ol style="list-style-type: none"> 1. Check the power supply of the PLC. 2. Confirm that the PLC is in the RUN state. 3. Check the connection of the communication circuit of the PLC. 4. Check whether the setting of the ten's digit of F8-57 complies with the application.

A42	Speed feedback error too large
Possible causes	<ol style="list-style-type: none"> 1. The encoder parameters are set improperly. 2. The motor auto-tuning is not performed. 3. The parameter F9-69 is set improperly. 4. The cable connection between the encoder and the PG card is abnormal. 5. The PG card is abnormal. 6. The 24 V and 15 V switching-mode power supply is abnormal. 7. The main control board is abnormal. 8. The encoder is abnormal
Solutions	<ol style="list-style-type: none"> 1. Set the encoder parameters in group F1 properly. 2. Perform the motor auto-tuning first and then operate the system. 3. Set F9-69 properly according to the actual condition. 4. Connect the cable between the encoder and the PG card properly and check whether cable connection breaks or is virtual according to the encoder instructions. 5. Check whether the cables of the MF38PG5 card are in good contact and whether the cables are connected properly. 6. Check whether the 24 V and 15 V switching-mode power supply. If abnormal, replace the I/O board 7. Replace the I/O board or the main control board. 8. Replace the encoder.
A43	Motor overspeed
Possible causes	<ol style="list-style-type: none"> 1. The encoder parameters are set improperly. 2. The motor auto-tuning is not performed. 3. The parameter F9-69 is set improperly. 4. The cable connection between the encoder and the PG card is abnormal. 5. The PG card is abnormal. 6. The 24 V and 15 V switching-mode power supply is abnormal. 7. The main control board is abnormal. 8. The encoder is abnormal
Solutions	<ol style="list-style-type: none"> 1. Set the encoder parameters in group F1 properly. 2. Perform the motor auto-tuning first and then operate the system. 3. Set F9-69 properly according to the actual condition. 4. Connect the cable between the encoder and the PG card properly and check whether cable connection breaks or is virtual according to the encoder instructions. 5. Check whether the cables of the MF38PG5 card are in good contact and whether the cables are connected properly. 6. Check whether the 24 V and 15 V switching-mode power supply. If abnormal, replace the I/O board 7. Replace the I/O board or the main control board. 8. Replace the encoder.

A46	Control power alarm
Possible causes	<ol style="list-style-type: none"> 1. The 24 V control power is abnormal. 2. The control power detection circuit is abnormal. 3. The DI terminal of the I/O board is abnormal. 4. The control hardware is abnormal.
Solutions	<ol style="list-style-type: none"> 1. Check whether the 24 V power is applied to the control system. 2. Check the control power detection circuit. 3. Use another DI terminal or replace the I/O board 4. Replace the I/O board or the main control board.
A51	Magnetic pole position detection failed
Possible causes	Contact Inovance for technical support.
Solutions	Contact Inovance for technical support.
A52	DP communication alarm
Possible causes	<ol style="list-style-type: none"> 1. The communication between the DP card and the PLC master is interrupted. 2. The setting of the station No. of the DP card slaves exceeds the limit. 3. The communication between the DP card and the PLC communication master times out.
Solutions	<ol style="list-style-type: none"> 1. Check whether the communication connection between the DP card and the PLC master is normal and reliable. 2. Modify the station No. of the DP card slaves to the allowable range. 3. Modify the PROFIBUS-DP communication timeout time (Fd-08)
A80	Power cell overtemp.
Possible causes	<ol style="list-style-type: none"> 1. The ambient temperature is too high. 2. The power cell is not well ventilated. 3. The dust filter is blocked 4. The fan is damaged. 5. The power cell control board is abnormal.
Solutions	<ol style="list-style-type: none"> 1. Lower the ambient temperature. 2. Replace the cell and contact Inovance for technical support. 3. Clean the dust filter. 4. Check whether the fan rotates in the reverse direction or whether the fan is damaged. 5. Replace the power cell control board.

A81	Power cell input phase loss
Possible causes	<ol style="list-style-type: none"> 1. The input terminals of the power cell are wrongly connected. 2. A fault occurs on the phase-shifting transformer. 3. The fuse of the power cell melts. 4. The power cell control board is abnormal.
Solutions	<ol style="list-style-type: none"> 1. Check and re-connect the input terminals correctly. 2. Contact Inovance for technical support. 3. Replace the fuse and eliminate the other problems that may result in fuse melting. 4. Replace the power cell control board.
A82	Analog break
Possible causes	<ol style="list-style-type: none"> 1. The analog input of AI1 to AI4 is small or breaks. 2. The actually used AI is not corresponding to the AI setting in A6-90. 3. The DI terminal is abnormal. 4. The I/O board is abnormal.
Solutions	<ol style="list-style-type: none"> 1. Check the AI connection and ensure correct wiring. 2. Make sure that the AI setting in A6-90 corresponds to the actually used AI. 3. Use another DI terminal or replace the I/O board. 4. Replace the I/O board.
A83	Power cell bypass alarm
Possible causes	<ol style="list-style-type: none"> 1. A power cell is bypassed. 2. The power cell bypass board feedback state is wrong. 3. The power cell control board is abnormal.
Solutions	<ol style="list-style-type: none"> 1. View the historical log, make clear why the power cell is bypassed, and replace the power cell. 2. Re-apply the medium voltage and complete power cell self-check. Then check whether the power cell bypass board is normal on the HMI. 3. Replace the power cell control board.
A84	Line-voltage contactor feedback abnormal
Possible causes	<ol style="list-style-type: none"> 1. The line-voltage contactor feedback signal line is wrongly connected or the feedback signal gets lost. 2. The line-voltage contactor is damaged.
Solutions	<ol style="list-style-type: none"> 1. Check the line-voltage contactor feedback signal line and ensure the line is connected correctly and securely. 2. Check whether the line-voltage contactor is normal.

A85	Transformer overload pending
Possible causes	<ol style="list-style-type: none"> 1. The load is too heavy or locked-rotor occurs on the motor. 2. The transformer is abnormal. 3. The AC drive size is small.
Solutions	<ol style="list-style-type: none"> 1. Reduce the load and check the motor and mechanical conditions. 2. Contact Inovance for technical support. 3. Replace a large drive.
A86	Motor overload pending
Possible causes	<ol style="list-style-type: none"> 1. The motor protection parameters are set improperly. 2. The load is too heavy or locked-rotor occurs on the motor. 3. The motor is abnormal. 4. The three-phase output voltage sampling is abnormal. 5. The control hardware is abnormal.
Solutions	<ol style="list-style-type: none"> 1. Set F9-01 to F9-03 properly. 2. Reduce the load and check the motor and mechanical conditions. 3. Check whether the motor is normal and whether the three-phase winding insulation is normal. 4. Locked-rotor occurs on the motor or the output current reaches the setting upper limit. Check whether the three-phase output voltage sampling board is normal and whether the three-phase output voltage sampling circuit is normal. 5. Replace the control hardware and contact Inovance for technical support.
A87	Phase-shifting transformer overtemp.
Possible causes	<ol style="list-style-type: none"> 1. The ambient temperature is too high (above 40°C). 2. The dust filter is blocked 3. The cross-flow fan works abnormally. 4. The fan on the cabinet roof works abnormally. 5. The AC drive overtemp. fault detection circuit signal is abnormal. 6. The temperature controller is damaged. 7. The cooling circuit of the transformer is faulty. 8. The DI circuit of the I/O board is abnormal. 9. The control hardware is abnormal.

Solutions	<ol style="list-style-type: none"> 1. Check the ambient temperature and make a record. 2. Clean the dust filter. 3. Check the cross-flow fan. 4. Check whether the fan on the cabinet roof rotates in the reverse direction or whether the fan is damaged. 5. Check whether breaking, virtual connection or wrong connection exists on the AC drive overtemp. fault detection circuit. 6. Check the temperature controller and its circuit. 7. Check the transformer cooling circuit. 8. Use another DI or replace the I/O board. 9. Replace the I/O board or the main control board, and contact Inovance for technical support.
-----------	--

A88	Cross-flow fan state feedback loss
Possible causes	<ol style="list-style-type: none"> 1. The cross-flow fan is not started. 2. The power supply of the cross-flow fan is abnormal. 3. The cross-flow fan state detection circuit is abnormal. 4. The thermal relay is abnormal. 5. The DI circuit of the I/O board is abnormal.
Solutions	<ol style="list-style-type: none"> 1. Start the cross-flow fan via the temperature controller. 2. Check power cables of the cross-flow fan. 3. Check whether breaking, virtual connection or wrong connection exists on the cross-flow fan state detection circuit . 4. Check whether the setting value of the thermal relay is correct and whether the thermal relay is normal. 5. Use another DI or replace the I/O board. 6. Replace the I/O board or the main control board, and contact Inovance for technical support.

A89	AC drive contactor feedback abnormal
Possible causes	<ol style="list-style-type: none"> 1. The AC drive contactor feedback signal line is wrongly connected or the feedback signal gets lost. 2. The AC drive contactor is damaged.
Solutions	<ol style="list-style-type: none"> 1. Check the AC drive contactor feedback signal line and ensure the line is connected correctly and securely. 2. Check whether the AC drive contactor is normal.

A120	Input voltage unbalanced
Possible causes	<ol style="list-style-type: none"> 1. The three-phase input voltage sampling board is abnormal. 2. The three-phase input voltage sampling circuit is abnormal. 3. The control hardware is abnormal. 4. The grid input voltage is abnormal.
Solutions	<ol style="list-style-type: none"> 1. Check whether the three-phase input voltage sampling board is normal, whether the resistance value of the sampling board is correct, whether the phase sequence is correct, and whether the R, S, T cables of the AC drive are connected properly. 2. Check whether breaking, wrong connection or virtual connection exists on the three-phase input voltage sampling circuit. 3. Replace the I/O board or the main control board. 4. Check whether the grid voltage on the user input side is abnormal.
A121	Output voltage unbalanced
Possible causes	<ol style="list-style-type: none"> 1. The three-phase output voltage sampling board is abnormal. 2. The three-phase output voltage sampling circuit is abnormal. 3. The control hardware is abnormal.
Solutions	<ol style="list-style-type: none"> 1. Check whether the three-phase output voltage sampling board is normal, whether the resistance value of the sampling board is correct, whether the phase sequence is correct, and whether the U, V, W cables of the AC drive are connected properly. 2. Check whether breaking, wrong connection or virtual connection exists on the three-phase output voltage sampling circuit. 3. Replace the I/O board or the main control board.
A180	Up transfer time-out
Possible causes	<ol style="list-style-type: none"> 1. The load is too heavy. 2. The feedback of the contactor used for synchronous transfer is abnormal.
Solutions	<ol style="list-style-type: none"> 1. Reduce the load. 2. Check the feedback signal of the contactor used for synchronous transfer
A181	Input sampling wiring wrong
Possible causes	<ol style="list-style-type: none"> 1. The phase sequence of the three-phase input voltage sampling is incorrect. 2. The input current sampling phase sequence is incorrect.
Solutions	<ol style="list-style-type: none"> 1. Check whether the phase sequence from the three-phase input voltage sampling board to the I/O board input voltage sampling lines is correct. 2. Check whether the IR and IT input current sampling phase sequence is correct.

9.2 System Faults

F02	Overcurrent during acceleration
Possible causes	<ol style="list-style-type: none">1. The output current sampling circuit is abnormal.2. The output hall is abnormal.3. The control mode is vector control but motor auto-tuning is not performed.4. The setting of F9-30 (AC drive overcurrent protection threshold) is small.5. The main control board is abnormal.6. The spinning motor is started.7. A sudden load is added during acceleration.8. The AC drive size is small.
Solutions	<ol style="list-style-type: none">1. Check whether wiring of the output current sampling circuit is correct and whether breaking or virtual connection exists on the circuit. Check whether the output hall is installed in the reverse direction.2. Apply $\pm 15\text{ V}$ to the output hall to check whether the M signal is connected correctly. Replace the output hall.3. Perform motor auto-tuning first and then start vector control.4. Increase F9-30 properly.5. Replace the main control board and re-set the AC drive parameters.6. Enable the catching a spinning motor function or start the motor after it stops completely.7. Remove the added load.8. Replace a larger drive.9. Check the serial connection cable and center cable on output side of power cells.

F03	Overcurrent during deceleration
Possible causes	<ol style="list-style-type: none"> 1. The output current sampling circuit is abnormal. 2. The output hall is abnormal. 3. The control mode is vector control but motor auto-tuning is not performed. 4. The setting of F9-30 (AC drive overcurrent protection threshold) is small. 5. The main control board is abnormal. 6. The spinning motor is started. 7. A sudden load is added during deceleration. 8. The AC drive size is small.
Solutions	<ol style="list-style-type: none"> 1. Check whether wiring of the output current sampling circuit is correct and whether breaking or virtual connection exists on the circuit. Check whether the output hall is installed in the reverse direction. 2. Apply ± 15 V to the output hall to check whether the M signal is connected correctly. Replace the output hall. 3. Perform motor auto-tuning first and then start vector control. 4. Increase F9-30 properly. 5. Replace the main control board and re-set the AC drive parameters. 6. Enable the catching a spinning motor function or start the motor after it stops completely. 7. Remove the added load. 8. Replace a larger drive. 9. Check the serial connection cable and center cable on output side of power cells.
F04	Overcurrent at constant speed
Possible causes	<ol style="list-style-type: none"> 1. The output current sampling circuit is abnormal. 2. The output hall is abnormal. 3. The control mode is vector control but motor auto-tuning is not performed. 4. The setting of F9-30 (AC drive overcurrent protection threshold) is small. 5. The main control board is abnormal. 6. The spinning motor is started. 7. A sudden load is added at constant speed. 8. The AC drive size is small.

Solutions	<ol style="list-style-type: none"> 1. Check whether wiring of the output current sampling circuit is correct and whether breaking or virtual connection exists on the circuit. Check whether the output hall is installed in the reverse direction. 2. Apply $\pm 15\text{ V}$ to the output hall to check whether the M signal is connected correctly. Replace the output hall. 3. Perform motor auto-tuning first and then start vector control. 4. Increase F9-30 properly. 5. Replace the main control board and re-set the AC drive parameters. 6. Enable the catching a spinning motor function or start the motor after it stops completely. 7. Remove the added load. 8. Replace a larger drive. 9. Check the serial connection cable and center cable on output side of power cells.
F05	Overvoltage during acceleration
Possible causes	The input voltage is very high and the system is in the acceleration state.
Solutions	Adjust the input voltage to the normal range.
F06	Overvoltage during deceleration
Possible causes	The input voltage is very high and the system is in the deceleration state.
Solutions	Adjust the input voltage to the normal range.
F07	Overvoltage at constant speed
Possible causes	The input voltage is very high and the system is in the constant state.
Solutions	Adjust the input voltage to the normal range.
F09	Input undervoltage
Possible causes	<ol style="list-style-type: none"> 1. The medium voltage is not applied during the drive running. 2. The three-phase input voltage sampling board is abnormal. 3. The input voltage sampling circuit of the AC drive is abnormal. 4. The input voltage of the AC drive is not within the normal range. 5. The control hardware is abnormal.
Solutions	<ol style="list-style-type: none"> 1. Stop the running, apply the medium voltage after checking is complete and 2. Check whether the three-phase input voltage sampling board is normal, whether the resistance value of the sampling board is correct, whether the phase sequence is correct, and whether the R, S, T cables of the AC drive are connected properly. 3. Check whether breaking, wrong connection or virtual connection exists on the three-phase input voltage sampling circuit. 4. Adjust the input voltage to the normal range. 5. Replace the I/O board or the main control board.

F10	AC drive overload
Possible causes	<ol style="list-style-type: none"> 1. The load is too heavy or locked-rotor occurs on the motor. 2. The transformer is abnormal. 3. The AC drive size is small.
Solutions	<ol style="list-style-type: none"> 1. Reduce the load and check the motor and mechanical conditions. 2. Contact Inovance for technical support. 3. Replace a larger drive.
F11	Motor overload
Possible causes	<ol style="list-style-type: none"> 1. Check whether the motor overload protective parameters (F9-01 to F9-03) are set improperly. 2. Check whether the load is too heavy or locked-rotor occurs on the motor. 3. The motor is abnormal. 4. The sampling of three-phase output voltage is abnormal. 5. The control hardware is abnormal.
Solutions	<ol style="list-style-type: none"> 1. Set F9-01 to F9-03 properly. 2. Reduce the load and check the motor and mechanical conditions. 3. Check whether the motor is abnormal and the three-phase winding insulation is normal. 4. Locked-rotor occurs on the motor or the output current reaches the setting upper limit. Check whether the three-phase output voltage sampling board is normal and whether the three-phase output voltage sampling circuit is normal. 5. Replace the I/O board or the main control board.
F12	Power input phase loss
Possible causes	<ol style="list-style-type: none"> 1. The three-phase input power is abnormal. 2. The three-phase input voltage sampling board is abnormal. 3. The input voltage sampling circuit of the AC drive is abnormal. 4. The control hardware is abnormal.
Solutions	<ol style="list-style-type: none"> 1. Eliminate external faults. 2. Check whether the three-phase input voltage sampling board is normal, whether the resistance value of the sampling board is correct, whether the phase sequence is correct, and whether the R, S, T cables of the AC drive are connected properly. 3. Eliminate the fault on the three-phase input voltage sampling circuit. 4. Replace the I/O board or the main control board. Contact Inovance for technical support.

F13	Power output phase loss
Possible causes	<ol style="list-style-type: none"> 1. The cable connecting the AC drive and the motor is abnormal. 2. The outputs of the AC drive are not connected to the motor. 3. The output current sampling circuit of the AC drive is abnormal. 4. The control hardware is abnormal.
Solutions	<ol style="list-style-type: none"> 1. Eliminate external faults. 2. Connect the outputs of the AC drive to the motor. 3. Check whether the output current sampling circuit is normal. 4. Replace the I/O board or the main control board.
F15	External alarm
Possible causes	The external fault signal is input through a multi-functional DI terminal.
Solutions	Reset the operation
F16	Communication alarm
Possible causes	<ol style="list-style-type: none"> 1. The customer's RS485/CAN interface is abnormal. 2. The communication cable is damaged. 3. The communication parameters in group Fd are set incorrectly.
Solutions	<ol style="list-style-type: none"> 1. Check whether the customer's RS485/CAN interface works properly. 2. Check the communication cable. 3. Set the communication parameters correctly.
F18	Current detection fault
Possible causes	<ol style="list-style-type: none"> 1. The output hall sampling circuit is abnormal. 2. The output hall is abnormal. 3. The ± 15 V power supply of the I/O board is abnormal. 4. The control hardware is abnormal.
Solutions	<ol style="list-style-type: none"> 1. Check whether breaking, virtual connection or wrong connection exists on the output current sampling circuit. 2. Apply ± 15 V to the output hall to check whether the M signal is connected correctly. Replace the output hall. 3. Use multimeter to measure the ± 15 V power supply of the I/O board. 4. Replace the I/O board or the main control board.

F19	Motor auto-tuning fault
Possible causes	<ol style="list-style-type: none"> 1. The three-phase output current sampling is abnormal. 2. The output hall is abnormal. 3. The three-phase output voltage sampling is abnormal. 4. The three-phase output voltage sampling board is abnormal. 5. The outputs of the AC drive are not connected to the motor. 6. An external force drives the motor. 7. The parameters in group F1 are not set according to the motor nameplate. 8. The control hardware is abnormal.
Solutions	<ol style="list-style-type: none"> 1. Check whether breaking, virtual connection or wrong connection exists on the output current sampling circuit. 2. Apply ± 15 V to the output hall to check whether the M signal is connected correctly. Replace the output hall. 3. Check whether breaking, wrong connection or virtual connection exists on the three-phase output voltage sampling circuit. Check whether the U, V, W cables of the AC drive are connected properly. 4. Check whether breaking, wrong connection or virtual connection exists on the three-phase input voltage sampling circuit. 5. Connect the outputs of the AC drive to the motor. 6. Cancel the external force. 7. Set the parameters in group F1 correctly. 8. Replace the I/O board or the main control board.
F20	Encoder fault
Possible causes	<ol style="list-style-type: none"> 1. The parameters in group F1 are set incorrectly. 2. The cable connection between the encoder and the PG card is abnormal. 3. The PG card is abnormal 4. The 24 V and 15 V switching-mode power supply is abnormal. 5. The encoder is abnormal 6. The main control board is abnormal.
Solutions	<ol style="list-style-type: none"> 1. Set the parameters in group F1 correctly. 2. Connect the cable between the encoder and the PG card properly and check whether cable connection breaks or is virtual according to the encoder instructions. 3. Check whether the cables of the MF38PG5 card are in good contact and whether the cables are connected properly. 4. Check whether the 24 V and 15 V switching-mode power supply. If abnormal, replace the I/O board 5. Replace the encoder. 6. Replace the I/O board or the main control board.

F21	EEPROM read-write fault
Possible causes	The EEPROM chip is damaged.
Solutions	Replace the main control board.
F23	Output impedance too small
Possible causes	<ol style="list-style-type: none"> 1. The three-phase output voltage sampling board is abnormal. 2. The three-phase output voltage sampling circuit is abnormal. 3. The insulation to ground of the motor three-phase winding is abnormal. 4. The insulation to ground of the AC drive outputs is abnormal. 5. The control hardware is abnormal.
Solutions	<ol style="list-style-type: none"> 1. Check whether the three-phase output voltage sampling board is normal, whether the resistance value of the sampling board is correct, whether the phase sequence is correct, and whether the U, V, W cables of the AC drive are connected properly. 2. Check whether breaking, wrong connection or virtual connection exists on the three-phase output voltage sampling circuit. 3. Disconnect the motor from the AC drive and eliminate the motor three-phase winding insulation problem. 4. Disconnect the motor from the AC drive and then use multimeter to measure the impedance to ground of the U, V, W outputs of the AC drive. Normally, the impedance to ground is megohm to infinity. 5. Replace the I/O board or the main control board.
F26	Accumulative running time reached
Possible causes	Contact Invoance for technical support.
Solutions	Contact Invoance for technical support.
F27	User-defined fault 1
Possible causes	<ol style="list-style-type: none"> 1. The user-defined fault 1 signal is input through a multi-functional DI terminal. 2. The I/O board is abnormal.
Solutions	<ol style="list-style-type: none"> 1. Reset the operation. 2. Use another DI terminal or Replace the I/O board.
F28	User-defined fault 2
Possible causes	<ol style="list-style-type: none"> 1. The user-defined fault 2 signal is input through a multi-functional DI terminal. 2. The I/O board is abnormal.
Solutions	<ol style="list-style-type: none"> 1. Reset the operation. 2. Use another DI terminal or Replace the I/O board.
F29	Accumulative power-on time reached
Possible causes	Contact Invoance for technical support.
Solutions	Contact Invoance for technical support.

F30	Load lost
Possible causes	<ol style="list-style-type: none"> 1. The load is disconnected during the drive running. 2. The control hardware is abnormal.
Solutions	<ol style="list-style-type: none"> 1. Check whether the load is disconnected during the drive running, and check whether the setting of F9-64 and F9-65 satisfies the operating condition. 2. Replace the I/O board or the main control board.
F31	PID feedback lost during the drive running
Possible causes	The PID feedback is smaller than the setting of FA-26.
Solutions	Check the PID feedback signal or set FA-26 properly.
F32	Input impedance too small
Possible causes	<ol style="list-style-type: none"> 1. The three-phase input voltage sampling board is abnormal. 2. The three-phase input voltage sampling circuit is abnormal. 3. The insulation to ground of the AC drive inputs is abnormal. 4. The control hardware is abnormal. 5. The transformer is abnormal.
Solutions	<ol style="list-style-type: none"> 6. Check whether breaking, wrong connection or virtual connection exists on the three-phase input voltage sampling circuit. 7. Disconnect the AC drive from the grid and then use multimeter to measure the impedance to ground of the R, S, T inputs of the AC drive. Normally, the impedance to ground is above megohm to infinity. 8. Replace the I/O board or the main control board. 9. Contact Inovance for technical support.
F34	Transformer overload
Possible causes	<ol style="list-style-type: none"> 1. Check whether the load is too heavy or locked-rotor occurs on the motor. 2. The AC drive size is small. 3. The control hardware is abnormal. 4. The transformer is abnormal.
Solutions	<ol style="list-style-type: none"> 1. Reduce the load and check the motor and mechanical conditions. 2. Replace a larger drive. 3. Replace the I/O board or the main control board. 4. Contact Inovance for technical support.
F35	Transformer no-load current abnormal
Possible causes	<ol style="list-style-type: none"> 1. The transformer is abnormal. 2. The input current detection circuit is abnormal.
Solutions	<ol style="list-style-type: none"> 1. Contact Inovance for technical support. 2. Contact Inovance for technical support.

F36	Input current unbalanced
Possible causes	<ol style="list-style-type: none"> 1. The input current detection circuit is abnormal. 2. The input current sampling mutual inductors are abnormal. 3. The input side of the transformer is abnormal. 4. The control hardware is abnormal.
Solutions	<ol style="list-style-type: none"> 1. Check the input current detection circuit. Check whether the connection breaks or whether the connection is virtual. 2. Check the two levels of mutual inductors are installed properly and eliminate the faults. 3. Contact Inovance for technical support. 4. Replace the I/O board or the main control board.
F37	Input voltage exceeding the limit
Possible causes	<ol style="list-style-type: none"> 1. Check whether the AC drive is connected to the correct medium-voltage grid. 2. The three-phase input voltage sampling board is abnormal. 3. The three-phase input voltage sampling circuit is abnormal. 4. The control hardware is abnormal.
Solutions	<ol style="list-style-type: none"> 1. Confirm that the AC drive is connected to the correct medium-voltage grid. 2. Check whether the three-phase input voltage sampling board is normal, whether the resistance value of the sampling board is correct, whether the phase sequence is correct, and whether the R, S, T cables of the AC drive are connected properly. 3. Check whether breaking, wrong connection or virtual connection exists on the three-phase input voltage sampling circuit. 4. Replace the I/O board or the main control board.
F38	Output current unbalanced
Possible causes	<ol style="list-style-type: none"> 1. The cables connecting the AC drive and the motor are not secure. 2. The output current sampling circuit of the AC drive is abnormal. 3. The output current sampling hall is damaged. 4. The control hardware is abnormal. 5. The parameters in group F1 are set incorrectly.
Solutions	<ol style="list-style-type: none"> 1. Check cable connection and tighten the screws. 2. Check the output current sampling circuit of the AC drive. 3. Replace the output sampling hall. 4. Replace the I/O board or the main control board. 5. Set the parameters in group F1 correctly.

F39	PLC communication abnormal
Possible causes	<ol style="list-style-type: none"> 1. The PLC is not powered on. 2. The PLC does not run. 3. The communication circuit between the PLC and the main control board is abnormal. 4. The PLC is not configured but detecting whether the PLC is normal is enabled.
Solutions	<ol style="list-style-type: none"> 1. Check the power supply of the PLC. 2. Confirm that the PLC is in the RUN state. 3. Check the connection of the communication circuit of the PLC. 4. Check whether the setting of the ten's digit of F8-57 complies with the application.
F41	Motor switchover fault during running
Possible causes	<ol style="list-style-type: none"> 1. The input of the DI terminal is abnormal. 2. The DI terminal is faulty. 3. The control hardware is abnormal.
Solutions	<ol style="list-style-type: none"> 1. Check whether the input of the DI terminal is correct. 2. Confirm that the used DI is a passive dry node. Use another DI terminal or replace the I/O board. 3. Replace the I/O board or the main control board.
F42	Speed feedback error too large
Possible causes	<ol style="list-style-type: none"> 1. The encoder parameters are set improperly. 2. The motor auto-tuning is not performed. 3. The speed feedback error too large detection parameters are set improperly. 4. The cable connection between the encoder and the PG card is abnormal. 5. The PG card is abnormal. 6. The 24 V and 15 V switching-mode power supply is abnormal. 7. The main control board is abnormal. 8. The encoder is abnormal
Solutions	<ol style="list-style-type: none"> 1. Set the encoder parameters in group F1 properly. 2. Perform the motor auto-tuning first and then operate the system. 3. Set F9-69 properly according to the actual condition. 4. Connect the cable between the encoder and the PG card properly and check whether cable connection breaks or is virtual according to the encoder instructions. 5. Check whether the cables of the MF38PG5 card are in good contact and whether the cables are connected properly. 6. Check whether the 24 V and 15 V switching-mode power supply. If abnormal, replace the I/O board 7. Replace the I/O board or the main control board. 8. Replace the encoder.

F43	Motor overspeed
Possible causes	<ol style="list-style-type: none"> 1. The encoder parameters are set improperly. 2. The motor auto-tuning is not performed. 3. The speed feedback error too large detection parameters are set improperly. 4. The cable connection between the encoder and the PG card is abnormal. 5. The PG card is abnormal. 6. The 24 V and 15 V switching-mode power supply is abnormal. 7. The main control board is abnormal. 8. The encoder is abnormal
Solutions	<ol style="list-style-type: none"> 1. Set the encoder parameters in group F1 properly. 2. Perform the motor auto-tuning first and then operate the system. 3. Set F9-69 properly according to the actual condition. 4. Connect the cable between the encoder and the PG card properly and check whether cable connection breaks or is virtual according to the encoder instructions. 5. Check whether the cables of the MF38PG5 card are in good contact and whether the cables are connected properly. 6. Check whether the 24 V and 15 V switching-mode power supply. If abnormal, replace the I/O board 7. Replace the I/O board or the main control board. 8. Replace the encoder.
F44	Pre-charge fault
Possible causes	<ol style="list-style-type: none"> 1. The pre-charge contactor is not closed. 2. The input voltage is insufficient. 3. The pre-charge circuit is abnormal. 4. The pre-charge controller is abnormal. 5. The bus voltage cannot be charged of a power cell. 6. Self-check cannot be completed due to power cell abnormality. 7. The control hardware is abnormal.
Solutions	<ol style="list-style-type: none"> 1. Confirm that the pre-charge contactor opens and closes normally. 2. Confirm the input voltage. 3. Check the connection of the pre-charge circuit and check whether breaking or virtual connection exists. 4. Check whether the pre-charge controller runs normally. 5. Check whether wiring of inputs of the power cells is correct. 6. Replace the power cell control board and pre-charge it again. 7. Replace the I/O board or the main control board.

F46	Control power fault
Possible causes	<ol style="list-style-type: none"> 1. The 24 V control power is abnormal. 2. The control power detection circuit is abnormal. 3. The DI terminal of the I/O board is abnormal. 4. The control hardware is abnormal.
Solutions	<ol style="list-style-type: none"> 1. Check whether the 24 V power is applied to the control system. 2. Check the control power detection circuit. 3. Use another DI terminal or replace the I/O board 4. Replace the I/O board or the main control board.
F47	The I/O board power abnormal
Possible causes	<ol style="list-style-type: none"> 1. The module power of the I/O board is abnormal. 2. The control hardware is abnormal.
Solutions	<ol style="list-style-type: none"> 1. Observe the module power indicator of the I/O board (in the POWER STATE area) and eliminate the problem. 2. Replace the I/O board or the main control board.
F48	Interaction data fault
Possible causes	<ol style="list-style-type: none"> 1. The jumpers at the DSP and ARM program-burning interfaces on the main control board are handled improperly. 2. The DSP program is being burnt. 3. The main control board is abnormal.
Solutions	<ol style="list-style-type: none"> 1. Handle the jumpers at the program-burning interfaces on the main control board by default. 2. After program burning is complete, handle the jumpers by default, and then switch on the control power. 3. Replace the I/O board or the main control board.
F49	Water cooling system fault
Possible causes	<ol style="list-style-type: none"> 1. Contact Inovance for technical support. 2. The DI circuit of the I/O board is abnormal. 3. The control hardware is abnormal.
Solutions	<ol style="list-style-type: none"> 1. Contact Inovance for technical support. 2. Use another DI terminal or replace the I/O board. 3. Replace the I/O board or the main control board.
F51	Magnetic pole position detection failed
Possible causes	Contact Inovance for technical support.
Solutions	Contact Inovance for technical support.

F52	DP card communication fault
Possible causes	<ol style="list-style-type: none"> 1. The communication between the DP card and the PLC master is interrupted. 2. The setting of the station No. of the DP card slaves exceeds the limit. 3. The communication between the DP card and the PLC communication master times out.
Solutions	<ol style="list-style-type: none"> 1. Check whether the communication connection between the DP card and the PLC master is normal and reliable. 2. Modify the station No. of the DP card slaves to the allowable range. 3. Modify the PROFIBUS-DP communication timeout time (Fd-08)
F55	Output overvoltage
Possible causes	<ol style="list-style-type: none"> 1. The motor power class and the AC drive power class do not match. 2. The parameters in group F1 are set incorrectly.
Solutions	<ol style="list-style-type: none"> 1. Select a matching AC drive or motor. 2. Check whether the parameters in group F1 are set correctly.
F57	Phase-shifting transformer overtemp. fault
Possible causes	<ol style="list-style-type: none"> 1. The ambient temperature is too high (above 40°C). 2. The dust filter is blocked 3. The cross-flow fan works abnormally. 4. The fan on the cabinet roof works abnormally. 5. The AC drive overtemp. fault detection circuit signal is abnormal. 6. The temperature controller is damaged. 7. The cooling circuit of the transformer is faulty. 8. The DI circuit of the I/O board is abnormal. 9. The control hardware is abnormal.
Solutions	<ol style="list-style-type: none"> 1. Check the ambient temperature and make a record. 2. Clean the dust filter. 3. Check the cross-flow fan. 4. Check whether the fan on the cabinet roof rotates in the reverse direction or whether the fan is damaged. 5. Check whether breaking, virtual connection or wrong connection exists on the AC drive overtemp. fault detection circuit. 6. Check the temperature controller and its circuit. 7. Check the transformer cooling circuit. 8. Use another DI or replace the I/O board. 9. Replace the I/O board or the main control board.

F58	Cabinet door travel switch fault
Possible causes	<ol style="list-style-type: none"> 1. The cabinet door is not closed properly. 2. The cabinet door travel switch is faulty. 3. The cabinet door travel switch fault detection circuit is abnormal. 4. The DI circuit of the I/O board is abnormal. 5. The control hardware is abnormal.
Solutions	<ol style="list-style-type: none"> 1. Check the cabinet door closing condition. 2. Check the cabinet door travel switch and its contact. 3. Check whether wrong connection, breaking or virtual connection exists on the cabinet door travel switch fault detection circuit. 4. Use another DI terminal or replace the I/O board. 5. Replace the I/O board or the main control board.
F59	Fan fault
Possible causes	<ol style="list-style-type: none"> 1. The wiring of the fan fault detection circuit is wrong. 2. The thermal relay is faulty. 3. The fan is faulty. 4. The DI circuit of the I/O board is abnormal. 5. The control hardware is abnormal.
Solutions	<ol style="list-style-type: none"> 1. Check the fan fault detection circuit. 2. Check whether the setting value of the thermal relay is correct and whether the thermal relay is normal. 3. Replace the fan on the cabinet roof. 4. Use another DI terminal or replace the I/O board. 5. Replace the I/O board or the main control board.
F120	Input voltage unbalanced
Possible causes	<ol style="list-style-type: none"> 1. The three-phase input voltage sampling board is abnormal. 2. The three-phase input voltage sampling circuit is abnormal. 3. The control hardware is abnormal. 4. The grid input voltage is abnormal.
Solutions	<ol style="list-style-type: none"> 1. Check whether the three-phase input voltage sampling board is normal, whether the resistance value of the sampling board is correct, whether the phase sequence is correct, and whether the R, S, T cables of the AC drive are connected properly. 2. Check whether breaking, wrong connection or virtual connection exists on the three-phase input voltage sampling circuit. 3. Replace the I/O board or the main control board. 4. Check whether the grid voltage on the user input side is abnormal.

F121	Output voltage unbalanced
Possible causes	<ol style="list-style-type: none"> 1. The three-phase output voltage sampling board is abnormal. 2. The three-phase output voltage sampling circuit is abnormal. 3. The control hardware is abnormal.
Solutions	<ol style="list-style-type: none"> 1. Check whether the three-phase output voltage sampling board is normal, whether the resistance value of the sampling board is correct, whether the phase sequence is correct, and whether the U, V, W cables of the AC drive are connected properly. 2. Check whether breaking, wrong connection or virtual connection exists on the three-phase output voltage sampling circuit. 3. Replace the I/O board or the main control board.
F122	Motor excitation fault
Possible causes	<ol style="list-style-type: none"> 1. The three-phase output voltage sampling board is abnormal. 2. The three-phase output voltage sampling circuit is abnormal. 3. The setting of F6-16 (Current of catching a spinning motor) is too large. 4. The control hardware is abnormal.
Solutions	<ol style="list-style-type: none"> 1. Check whether the three-phase output voltage sampling board is normal, whether the resistance value of the sampling board is correct, whether the phase sequence is correct, and whether the U, V, W cables of the AC drive are connected properly. 2. Check whether breaking, wrong connection or virtual connection exists on the three-phase output voltage sampling circuit. 3. Set F6-16 to the proper value that can satisfy the on-site requirement. Generally, the setting of F6-16 is smaller than F1-10 (No-load current). 4. Replace the I/O board or the main control board.

F160	Input voltage abnormal
Possible causes	<ol style="list-style-type: none">1. The three-phase input voltage sampling board is abnormal.2. The three-phase input voltage sampling circuit is abnormal.3. The control hardware is abnormal.4. The grid input voltage is abnormal.5. The circuit breaker feedback is abnormal.6. The pre-charge resistor is abnormal.
Solutions	<ol style="list-style-type: none">1. Check whether the three-phase input voltage sampling board is normal, whether the resistance value of the sampling board is correct, whether the phase sequence is correct, and whether the R, S, T cables of the AC drive are connected properly.2. Check whether breaking, wrong connection or virtual connection exists on the three-phase input voltage sampling circuit.3. Replace the I/O board or the main control board.4. Check whether the grid voltage on the user input side is abnormal.5. Check the circuit breaker and the input signal of the I/O board are normal.6. Check whether the pre-charge resistor is normal.
F161	Reactor overtemp.
Possible causes	<ol style="list-style-type: none">1. The reactor temperature is too high.2. The DI circuit of the I/O board is abnormal.3. The control hardware is abnormal.
Solutions	<ol style="list-style-type: none">1. Cool down the reactor.2. Use another DI terminal or replace the I/O board3. Replace the I/O board or the main control board.

9.3 Power Cell Faults

F60	Power cell fault
Possible causes	Contact Inovance for technical support.
Solutions	Contact Inovance for technical support.
F61	Power cell communication fault
Possible causes	<ol style="list-style-type: none"> 1. The 5 V power cables of the optical fiber board is not connected. 2. The optical fiber head has dirt. 3. The connector of the optical fiber becomes loose. 4. The optical fiber is damaged. 5. The power cell is faulty. 6. The optical fiber board is faulty. 7. The cabling between the optical fiber board and the main control board is problematic. 8. The main control board is faulty.
Solutions	<ol style="list-style-type: none"> 1. Connect the 5 V power cables of the optical fiber board correctly. 2. Clean the optical fiber head. 3. Re-connect the optical fiber. 4. Replace the optical fiber. 5. Replace the power cell control board. 6. Replace the optical fiber board. 7. Re-connect the cables between the optical fiber board and the main control board. 8. Replace the main control board.
F62	Power cell blocked
Possible causes	<ol style="list-style-type: none"> 1. The power device is abnormal. 2. The power cell control board is abnormal.
Solutions	<ol style="list-style-type: none"> 1. Replace a power cell of the same power class. 2. Replace the power cell control board.
F63	Power cell overcurrent
Possible causes	<ol style="list-style-type: none"> 1. The power device is abnormal. 2. The power cell is abnormal. 3. The main control board is abnormal.
Solutions	<ol style="list-style-type: none"> 1. Replace a power cell of the same power class. 2. Replace the power cell control board. 3. Replace the main control board.

F65	Power cell voltage balancing fault
Possible causes	<ol style="list-style-type: none"> 1. The voltage balancing resistor is damaged. 2. The connector of the voltage balancing resistor comes off. 3. The power cell control board is abnormal.
Solutions	<ol style="list-style-type: none"> 1. Contact Inovance. 2. Check that the connector of the voltage balancing resistor is connected securely. 3. Replace the power cell control board.
F66	Power cell overvoltage
Possible causes	<ol style="list-style-type: none"> 1. The grid voltage is very high. 2. The setting of F2-12 (Digital setting of braking torque upper limit in speed control mode) is too large. 3. The wiring of inputs of the faulty power cell is wrong. 4. The load inertia is large but the setting of the deceleration time is too short. 5. The power cell control board is abnormal. 6. The output current oscillates.
Solutions	<ol style="list-style-type: none"> 1. Lower the input voltage and adjust the transformer contact terminal to +5%. 2. Decrease F2-12 with the principle of ensuring the 50 Hz output voltage normal. 3. Check whether the wiring of inputs of the faulty power cell is abnormal. 4. Set longer deceleration time. 5. Replace the power cell control board. 6. Contact Inovance for technical support.
F68	Power cell overtemp.
Possible causes	<ol style="list-style-type: none"> 1. The ambient temperature is too high. 2. The power cell thermistor is damaged 3. The power cell is not well ventilated. 4. The dust filter is blocked 5. The fan is damaged. 6. The power cell control board is abnormal.
Solutions	<ol style="list-style-type: none"> 1. Lower the ambient temperature. 2. Replace the thermistor or replace a power cell of the same power class. 3. Replace the cell and contact Inovance for technical support. 4. Clean the dust filter. 5. Check whether the fan rotates in the reverse direction or whether the fan is damaged. 6. Replace the power cell control board.

F69	Power cell undervoltage
Possible causes	<ol style="list-style-type: none">1. The grid voltage is very low.2. The transformer is faulty.3. The power cell control board is abnormal.
Solutions	<ol style="list-style-type: none">1. Check the grid voltage and adjust the transformer contact terminal to -5%.2. Contact Inovance for technical support.3. Replace the power cell control board and contact Inovance for technical support.
F70	Power cell bypass fault
Possible causes	<ol style="list-style-type: none">1. The bypass contactor is faulty.2. The control cable of the bypass contactor is wrongly connected.3. The bypass board is faulty.4. The power cell control board is abnormal.
Solutions	<ol style="list-style-type: none">1. Replace the bypass contactor.2. Re-connect the control cable of the bypass contactor.3. Replace the bypass board.4. Replace the power cell control board and contact Inovance for technical support.
F71	Power cell fuse fault
Possible causes	Contact Inovance for technical support.
Solutions	Contact Inovance for technical support.

9.4 Replacing Damaged Power Cells

All power cells are the same and do not have highly matching requirements on power devices. If a power cell is damaged, the technician of the user can replace it with a normal one by performing the following steps.

1. Stop the AC drive by remote control or press the emergency stop button.
2. Cut off the MV power and wait for 15 minutes until all indicators of the power cells become OFF.
3. Remove the optical fiber connector of the damaged power cell.
4. Remove the connected cables and the tightening screws of the damaged power cell.
5. Pull the damaged power cell out along the track. Handle it with care.
6. Mount a new power cell, perform wiring and re-power on the system.
7. Contact Inovance to repair the damaged power cell.



Routine Maintenance and Repair

Chapter 10 Routine Maintenance and Repair

This chapter describes the precautions during maintenance and repair of the HD9X series MV AC drive.

DANGER

- Never touch the terminals of the AC drive within 10 minutes after the MV input is cut off. The terminals still have residual hazardous medium voltage.
- Maintain and repair the AC drive only after the main circuits are cut off and power cells discharge completely (the power cell power indicator in the OFF state).

WARNING

- Never touch the circuit board or the drive board directly with finger because electrostatic induction may damage the integrated circuit of the circuit board.
- Never change wiring or remove cables connecting to the terminals at power-on. Failure to comply may result in electric shock.

10.1 Precautions During Inspection

1. Before starting inspection, turn off the circuit breaker, pull down the knife switch and label a warning notice to prevent sudden power-on by others.
2. Ensure that the AC drive is in the stop state and the MV presence indicator is OFF.
3. After medium voltage and low voltage are cut off, perform electrical inspection before inspection. For medium voltage inspection, use an electroscope of the corresponding voltage class and wear insulated safety articles.
4. After verifying that the AC drive is de-energized, tie the input three phases of the AC drive to the ground to ensure personal safety.
5. Ground all parts of the AC drive which are liable to become energized. When inspecting a bus knife switch, an isolation switch or a load switch in double-circuit system, pull down both bus knife switches and ground the inspected switch at both ends.
6. When installing a grounding cable, make one end of the grounding cable grounded first, and then attach the other end. When removing a grounding cable, perform the operations in a reverse sequence. For either installation or removal, wear insulated safety articles.
7. Attach the grounding cable to the place where electrical engineer can see it at any time and label a "Working" warning notice there.
8. Perform inspection only after verifying that the residual DC voltage is lower than 20 V.

10.2 Precautions on Operations

- The HD9X series AC drive is a hazardous medium voltage device. Any operator must strictly observe the operation instructions.
- Power on the control power first. Switch on the MV power after MV switch-on is allowed.
- When using the HMI, press it slightly with finger. Never knock it or press it with a hard object.
- Never allow irrelevant personnel to use the HMI so as to avoid mal-function.
- Never open the cabinet door during the drive running. Otherwise, the system will report a fault and enable the input MV breaker, and even result in death.

10.3 Daily Check

The influence of the ambient temperature, humidity, smoke and aging of internal components of the AC drive may cause potential faults. Therefore, it is necessary to perform daily check on the AC drive during storage and use. Check whether any abnormality occurs, for example, cooling system abnormal, overtemp., discoloring, peculiar smell, abnormal noise and abnormal oscillation. Transcribe the input/output parameters of the AC drive at regular time.

Table 10-1 Daily checklist of the AC drive

Checking Part	Items	Method	Judging Criteria	Solution
Environment	<ul style="list-style-type: none"> • Dust, oil stain, water drop • Ambient temperature, humidity, vibration • Whether any foreign object and hazardous article exists. 	Observe	Ambient temperature: -10°C to 40°C Humidity: less than 95%RH	Improve the on-site environment.
Phase-shifting transformer	<ul style="list-style-type: none"> • Whether the cooling channel is blocked and whether the wire guide head is properly tightened without burnt sign. • Whether abnormal temperature rise occurs • Whether the phase-shifting transformer is clean. 	Observe	No abnormality	<ul style="list-style-type: none"> • Find the cause. • Clean the phase-shifting transformer.
HMI	<ul style="list-style-type: none"> • Resolution of the HMI 	Observe	No abnormality	Adjust the contrast and brightness.
Frame	<ul style="list-style-type: none"> • Whether there is abnormal vibration or noise • Whether screws (fastening pieces) become loose • Whether the frame deforms or is damaged • Whether there are dust and oil stain 	Listen Observe	No abnormality	Find the cause.

Checking Part	Items	Method	Judging Criteria	Solution
Cables	<ul style="list-style-type: none"> Whether cables discolor or deform due to overtemp. Whether the insulating layer gets worn or discolors 	Observe	No abnormality	Find the overtemp. cause.
Terminals	<ul style="list-style-type: none"> Whether any terminal is damaged 	Observe	No abnormality	Replace the damaged terminal.
Filter capacitor	<ul style="list-style-type: none"> Whether liquid leakage, discoloring, cracking and housing expansion occurs on the filter capacitor Measure electrostatic capacitance 	Observe Measure with multimeter	No abnormality Electrostatic capacitance \geq initial value x 0.85	Replace the capacitor.
Resistor	<ul style="list-style-type: none"> Whether any cable breaks Whether any insulator cracks 	Observe Measure with multimeter	The resistance value is within $\pm 10\%$.	Replace the resistor.
Transformer	<ul style="list-style-type: none"> Whether there is any abnormal vibration and peculiar smell. 	Observe Listen Smell	No abnormality	Find the cause.
PCB	<ul style="list-style-type: none"> Whether the screw and bolt become loose Whether the PCB has peculiar smell or discolors Whether the PCB cracks, is damaged, deformed, or is corroded Whether liquid leakage or deformation occurs on the capacitor 	Observe	No abnormality	Tighten the screw and bolt. Repair the PCB.
Cooling fan	<ul style="list-style-type: none"> Whether there is abnormal vibration or noise. 	Observe Listen	No abnormality	Replace the fan.
Air duct	<ul style="list-style-type: none"> Whether the air duct is blocked or adhered with foreign objects. 	Observe Listen	No abnormality	Clear away the foreign objects.

10.4 Periodical Repair and Maintenance

The HD9X series AC drive is highly reliable and maintenance-free. We still suggest the user to perform periodical maintenance.

1. Clean the dust filters on cabinet doors periodically to ensure good heat dissipation effect.
2. The operator on duty or maintenance engineer must inspect and check the transformer periodically. Record the temperature of the transformer windings, and ensure that this temperature in normal operating condition does not exceed 80°C.
3. After the transformer is put into operation, clean it every year.
4. Check and tighten all wiring screws every six months.
5. The voltage resistance test on the AC drive has been done before delivery. Never perform such test to avoid damage to the AC drive. However, you can check the insulation condition of the system periodically.
6. Power off the system periodically and open the cabinet doors to perform checking according to Table 10-1.

■ Handling of AC Drive in De-energized State for Over 90 Days

If the AC drive must be stored in the de-energized (medium voltage switch-off) state for over 90 days after you received, the storage environment of the whole unit must comply with the storage environment requirements of Inovance.

If you do not notify Inovance to commission the AC drive for over six months, Inovance will test the AC drive during commissioning for the first time. Please provide the medium-voltage drive for commissioning.

■ Storage of Spare Parts

The spare parts must be stored in the environment that satisfies the requirements in section 3.2.4.

The power cells contain a great number of capacitors. Long-term storage will degrade the electrolytic capacitors. Thus, energize the AC drive once every six months, and keep energizing the drive for more than one hour each time.

It is suggested that you use a voltage regulator for energizing the drive. Connect the outputs A, B, C of the voltage regulator to the inputs R, S, T of the power cells and adjust the output voltage to 450 to 690 V. Then observe the power cell state.

■ Description of Service Life of Drive Internal Components

To enable the AC drive to keep normal running, it is necessary to perform repair and maintenance based on the service life of internal components of the AC drive. Their service life is related to the operating environment and condition. The general service life of the internal components is listed in the following table.

Table 10-2 Service life of internal components

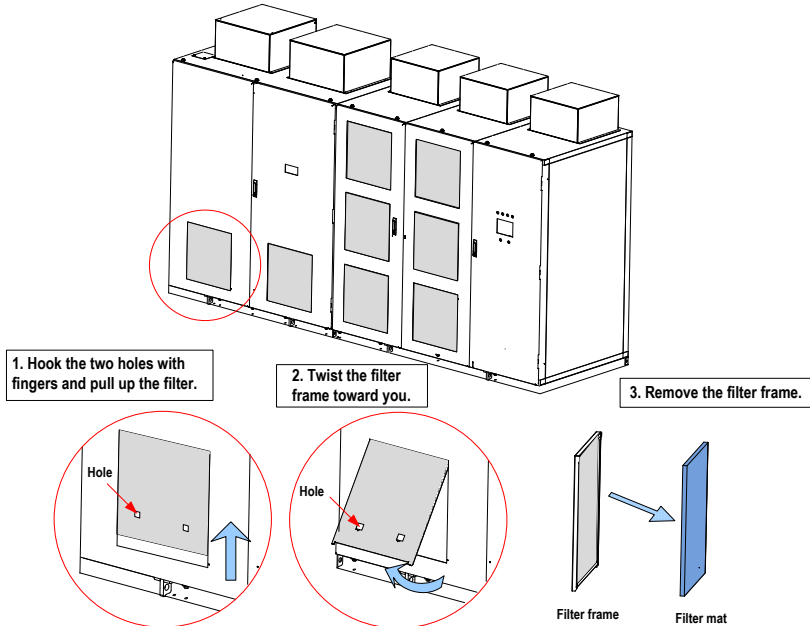
Component Name	Service Life
Cross-flow fan	2 to 3 years
Cabinet top fan	3 to 5 years
Electrolytic capacitor	5 to 8 years
Fuse	10 years

■ Replacement of Air Filter

The HD9X series AC drive adopts forced air cooling method, which causes dust accumulation around the air filters after the AC drive runs for a long time. To ensure normal heat dissipation, it is necessary to clean or replace the air filters (that are delivered together with the AC drive) periodically. It is suggested that the air filters are cleaned every 10 days. The cleaning period depends on the actual applications, and should be shortened in heavy dust scenario.

The procedure of cleaning or replacing the air filter is as follows:

Figure 10-1 Procedure of cleaning or replace the air filter



1. As shown in Figure 10-1, remove the filter and then clear the dust on the filter by using a vacuum cleaner. If the filter cannot be cleaned, replace it.
2. Install the air filter in the reverse steps.
3. Clean or replace the air filters on all cabinet doors of the HD9X one by one in the same way.

10.5 Disposal

When disposing obsolete AC drive and its components, pay attention to the following items:

- The electrolytic capacitors inside the AC drive may explode when they are burnt.
- Poisonous gas is generated when the PCB, plastic, rubber parts and epoxy board are burnt.
- Treat them as ordinary industrial waste.



Appendix

Appendix A HD9X Modbus Communication Protocol

The HD9X provides the RS485 communication interface and supports the Modbus-RTU communication protocol so that the user can implement centralized control, such as setting running commands and function codes, and reading working status and fault information of the AC drive.

A.1 About the Protocol

This protocol defines the content and format of transmitted messages during serial communication, including master polling (or broadcasting) format and master coding method (function code for the action, transmission data, and error check). The slave uses the same structure in the response, including action confirmation, data returning and error check. If an error occurs when the slave receives a message, or the slave cannot complete the action required by the master, the slave returns a fault message as a response to the master.

A.1.1 Application

The AC drive is connected to a "single-master multi-slave" PC/PLC control network with the RS485 bus.

A.1.2 Bus Structure

1. Hardware interface mode

The I/O interface board provides the RS3+ and RS3- hardware interfaces.

Note

Use the STP cable for communication and avoid using parallel lines to protect the communication signals from suffering external interference.

2. Topological structure

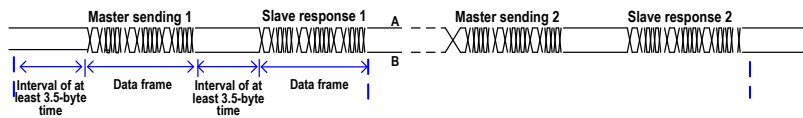
The system consists of a single master and multiple slaves. In the network, each communication device has a unique slave address. A device is the master (can be a PC, a PLC or an HMI) and initiates communication to perform parameter read or write operations on slaves. The other devices (slaves) provide data to respond to the query or operations from the master. At the same moment, either the master or the slave transmits data and the other can only receives data.

The address range of the slaves is 1 to 247. A slave address must be unique in the network.

3. Transmission mode

The asynchronous serial and half-duplex transmission mode is used. During asynchronous serial communication, data is sent frame by frame in the form of message. In the Modbus-RTU protocol, an interval of at least 3.5-byte time marks the end of the the previous message. A new message starts to be sent after this interval.

The asynchronous serial and half-duplex transmission mode is used. During asynchronous serial communication, data is sent frame by frame in the form of message. In the Modbus-RTU protocol, an interval of at least 3.5-byte time marks the end of the the previous message. A new message starts to be sent after this interval.



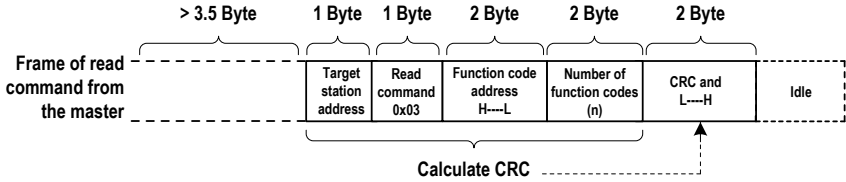
The communication protocol used by the HD9X is the Modbus-RTU slave communication protocol, which allows the HD9X to provide data to respond to the "query/command" from the master or execute the action according to the "query/command" from the master.

The master can be a PC, an industrial device, or a PLC. The master can communicate with a single slave or send broadcast messages to all slaves. For the "query/command" from the master, the slave needs to return a response frame.

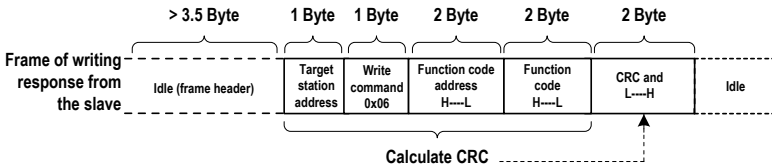
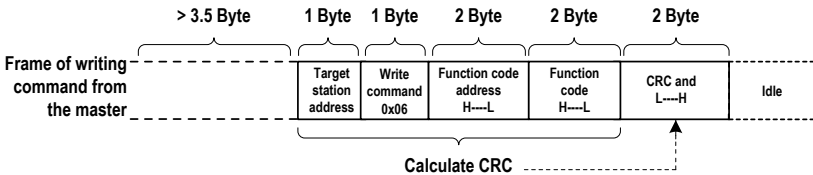
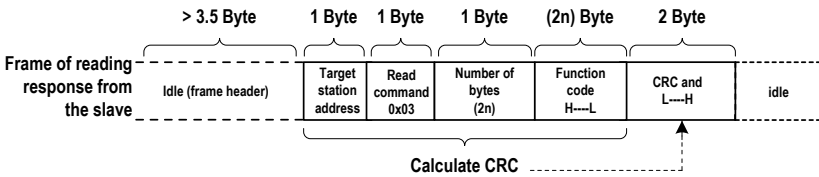
A.2 Communication Data Format

The HD9X supports reading and writing of word-type parameters only. The reading command is 0x03 and the writing command is 0x06. It does not support reading and writing of bytes or bits.

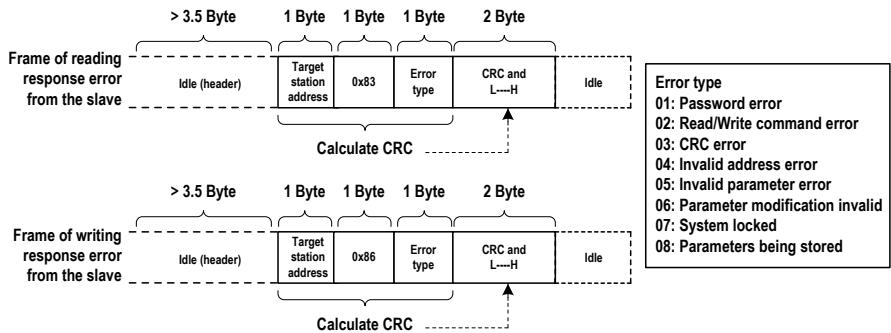
The Modbu-RTU protocol communication data format of the HD9X is as follows:



In theory, the host computer can read several consecutive parameters (n can reach up to 100) but the last parameter it reads must not jump to the next parameter group. Otherwise, an error occurs on the response.



If the slave detects a communication frame error or the reading/writing failure is caused by other reasons, an error frame will be returned as follows:



The frame format is described in the following table.

Frame header (START)	Greater than the 3.5-byte transmission idle time
Slave address (ADR)	Communication address : 1 to 247
Command code (CMD)	03: Read slave parameters 06: Write slave parameters
Function code address (H)	It is the internal parameter address of the AC drive, expressed in heximecal format. The parameters include functional parameters and non-functional parameters (running state and running command). During transmission, low-order bytes follow the high-order bytes.
Function code address (L)	
Number of function codes (H)	It is the number of function codes read by this frame. If it is 1, it indicates that one function code is read. During transmission, low bytes follow high bytes.
Number of function codes (L)	In the present protocol, only one function code is read once, and this field is unavailable.
Data (H)	It is the response data or data to be written. During transmission, low-order bytes follow the high-order bytes.
Data (L)	
CRC CHK high bytes	It is the detection value (CRC16 verification value). During transmission, low-order bytes follow the high-order bytes.
CRC CHK low bytes	
END	It is 3.5-byte transmission time.

- CRC check

In the Modbus-RTU mode, a message includes a CRC-based error-check field. The CRC field checks the content of the entire message. The CRC field is two bytes, containing a 16-bit binary value. The CRC field is calculated by the transmitting device, and then added to the message. The receiving device recalculates a CRC value after receiving the message, and compares the calculated value with the CRC value in the received CRC field.

The CRC is first stored to 0xFFFF. Then a procedure is invoked to process the successive 8-bit byte in the message and the value in the register. Only the eight bits in each character are used for the CRC. The start bit, stop bit and the parity bit do not apply to the CRC.

During generation of the CRC, each eight-bit character is in exclusive-OR (XOR) with the content in the register. Then the result is shifted in the direction of the least significant bit (LSB), with a zero filled into the most significant bit (MSB) position. The LSB is extracted and examined. If the LSB was a 1, the register then performs XOR with a preset value. If the LSB was a 0, no XOR is performed. This process is repeated until eight shifts have been performed. After the last (eighth) shift, the next eight-bit byte is in XOR with the register's current value, and the process repeats for eight more shifts as described above. The final value of the register, after all the bytes of the message have been applied, is the CRC value.

The CRC is added to the message from the low-order byte followed by the high-order byte. The CRC simple function is as follows:

```
unsigned int crc_chk_value (unsigned char *data_value,unsigned char length)
{
    unsigned int crc_value=0xFFFF;
    int i;
    while (length--)
    {
        crc_value^=*data_value++;
        for (i=0;i<8;i++)
        {
            if (crc_value&0x0001)
            {
                crc_value= (crc_value>>1) ^0xa001;
            }
            else
            {
                crc_value=crc_value>>1;
            }
        }
    }
    return (crc_value) ;
}
```

Note

Never modify the parameters that are only for the factory use or for monitoring.

A.3 Defination of Communication Parameter Addresses

You can implement control and monitoring of the AC drive, and view and modify the function parameters through the communication protocol on the RS485 terminal.

The communication data of the HD9X is classified into function code data and non-function code data. The latter includes the running commands, running states, running parameters and alarm information.

A.3.1 Function Code Data of HD9X

The function code data of the HD9X are the important function parameters of the AC drive, as shown below:

Function Code Data of HD9X	Group F	F0, F1, F2, F4, F5, F6, F8, F9, FA, FC, Fd
	Group A	A6

For descriptions of the function parameters, see chapter 7. When reading the function code data through communication, the communication address of the function code data is defined as follows:

For the function code data in groups F and A, the highest 8 bits in the communication address indicate the parameter group No., and the lowest 8 bits indicate the parameter identifying No. in the group.

For example,

The communication address of function code F0-27 is F01BH, amongst which F0H indicates the parameter group No. F0 and 1BH is the hexadecimal equivalent converted from the parameter identifying No. 27 in the group F0.

The communication address of function code Fd-05 is FD05, amongst which FDH indicates the parameter group No. Fd and 05H is the hexadecimal equivalent converted from the parameter identifying No. 5 in the group Fd.

A.3.1 Non-function Code Data of HD9X

Non-function Code Data of HD9X	State Data (Read-only)	Parameters in group U0, AC drive fault description, AC drive running state, User-modified parameters
	Control Parameters (Write-only)	Control commands, communication setting value, frequency reference

1. State parameters

- Monitoring parameters in group U

For the description of monitoring data in group U, see section 7.2. The communication address is defined as follows:

The highest 8 bits in the communication address of group U0 is 70H, and the lowest 8 bits indicate parameter identifying No. in group U0.

For example, the communication address of U0-23 is 7017H.

- Read AC drive state (read-only)

The communication address of reading the AC drive running state is 3000H. You can obtain the current AC drive running state by reading the data through this address on the RS485 terminal.

The communication address is defined as follows:

State Word Address	State Word Function
3000H	0001: Forward RUN
	0002: Reverse RUN
	0003: Stop

- Read AC drive fault description (read-only)

The communication address of reading the AC drive fault description is 8000H. You can obtain the current AC drive fault code by reading the data through this address on the host computer.

For description of fault codes, see chapter 9.

AC Drive Fault Address	AC Drive Fault Information
8000H	Range: 0 to 199.

2. Control parameters

- Frequency reference

The frequency reference here indicates the setting when the frequency reference setting channel of HD9X is communication. The communication address is 1000H. When you set this communication address on the RS485 terminal, the data range is -30000 to 30000.

Parameter Address	Parameter Description
1000H	Frequency reference (decimal): -30000 to 30000

- Communication setting

The communication setting is mainly used as the setting channel of torque upper limit, PID reference and PID feedback. The communication address is 1002H. When you set this communication address on the RS485 terminal, the data range is -30000 to 30000.

Parameter Address	Parameter Description
1002H	Communication setting (decimal): -30000 to 30000

- Control commands (write-only)

When the control mode is remote RS485 terminal, you can implement control of the AC drive such as run/stop through the communication address 2000H. The control commands are defined as follows:

State Word Address	State Word Function
2000H	0001: Forward run
	0002: Reverse run
	0005: Coast to stop
	0006: Stop according to the stop mode
	0007: Fault reset

Appendix B Extension DP Card (MD38DP2)

B.1 Overview

The PROFIBUS-DP card MD38DP2, is designed to connect the HD9X drive to PROFIBUS-DP bus, and enables the HD9X to be a slave in the bus, controller by the master.

The MD38DP2 complies with the international PROFIBUS field bus standard. It helps to save the hardware and installation charge and cost of construction, and is more flexible if you use the PROFIBUS-DP bus in the system.

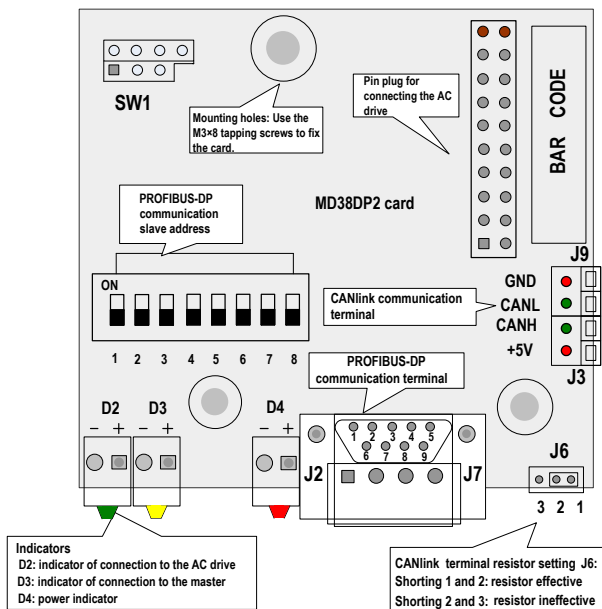
B.2 Hardware Layout and Interface Descriptions

WARNING

- The MD38DP2 must be embedded into the HD series MV AC drive. Before installing the card, switch off the MV power and the control power, wait for approximately 10 minutes until all power cell indicators go off, and then install the card.
- After inserting the MD38DP2 card into the AC drive, fix the card with screws to protect the signal sockets from being damaged due to the pulling force of external signal cables.

The hardware layout of the MD38DP2 is as follows:

Figure B-1 Hardware layout of the MD38DP2

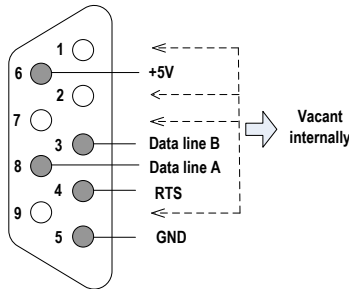


■ Description of DIP Switch and Address Setting

DIP Switch Bit	Function	Description										
1 to 8	The PROFIBUS-DP communication slave address	<p>The 8-bit binary DIP switch can set state addresses of 0 to 124.</p> <p>For example:</p> <table border="1"> <thead> <tr> <th>Address</th> <th>DIP switch setting</th> </tr> </thead> <tbody> <tr> <td>0</td> <td>0000 0000</td> </tr> <tr> <td>7</td> <td>0000 0111</td> </tr> <tr> <td>20</td> <td>0001 0100</td> </tr> <tr> <td>124</td> <td>0111 1100</td> </tr> </tbody> </table>	Address	DIP switch setting	0	0000 0000	7	0000 0111	20	0001 0100	124	0111 1100
Address	DIP switch setting											
0	0000 0000											
7	0000 0111											
20	0001 0100											
124	0111 1100											

■ Description of PROFIBUS 9-Pin Port

Figure B-2 Description of PROFIBUS 9-pin port



■ Description of Terminals and Jumpers

The following table describes the terminals of the MD38IO1.

Type	Terminal	Terminal Name	Function Description
PROFIBUS communication terminal (J2)	1, 2, 7, 9	NC	Vacant internally
	3	Data line B	Data line positive
	4	RTS	Request of sending signal
	5	GND	Isolation 5 V power ground
	6	+5V	Isolation 5 V power supply
	8	Data line A	Data line negative

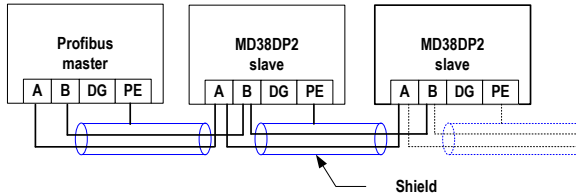
Type	Terminal	Terminal Name	Function Description
CANlink communication terminals (J3, J9)	+5V	Power supply	Isolation 5 V power supply
	CANH	CAN positive input	Data line positive
	CANL	CAN negative input	Data line negative
	GND	Power ground	Isolation 5 V power ground
Program write-in	SW1	Program write-in	It is the commissioning interface. Never use it.
Jumper	J6 (The white dot is pin 1.)	CANlink terminal resistor matching selection	1 and 2 shorted: matching the terminal resistor 2 and 3 shorted: not matching the terminal resistor
Indicators [1]	D4 in red	Power supply indicator	ON: indicates that the drive is powered on. OFF: indicates that the drive is not powered on or the DP card is installed improperly.
	D3 in yellow	DP card and master communication indicator	ON: indicates normal communication between the DP card and the master. OFF: indicates no communication between the DP card and the master (check the PROFIBUS cable connection and station No. setting). Flashing: indicates that the master does not operate or wrong communication between the DP card and the master.
	D2 in green	DP card and drive communication indicator	ON: indicates normal communication between the DP card and the drive. OFF: indicates that communication between the DP card and the drive fails (check the baud rate setting). Flashing: indicates that interference exists on the communication between the DP card and the drive or the extension card address is not within the rang of 1 to 125.

Note

The indicator color does not match the indicator SN in some products. The indicator SN shall prevail and is D2, D3, and D4 from left to right, as shown in Figure B-1.

■ Connecting to the PROFIBUS-DP master

Figure B-3 Connecting to the PROFIBUS-DP master



The MD38DP2 provides only one type of DB9 for connecting the PROFIBUS-DP master. The DB8 is standard Siemens DB9 socket and requires the PEs of the system to be grounded reliably. If the used baud rate is high, restrict the communication cable lead length strictly according to the Siemens DB9 standard. .

The length of the communication cable varies with different setting of the baud rate of the master. The following table describes the requirements on the baud rate and the communication cable.

Baud Rate (Kbps)	Max. Length of Lead A (m)	Max. Length of Lead B (m)
9.6	1200	1200
19.2	1200	1200
187.5	600	600
500	200	200
1500	100	70
3000	100	Not supported
6000	100	
12000	100	

Appendix C Extension Encoder Cards

The extension encoder cards are applicable to the all series products.

C.1 Overview

The HD9X provides multiple types of encoder extension cards (PG cards) for your choice. The PG card is necessary for closed-loop vector control. Select a proper PG card according to the encoder output mode. The PG card models are listed in the following table.

PG Card	Description	Others
MD38PG1	Differential input PG card with frequency dividing output	Terminal wiring
MD38PG5	OC input PG card with 1:1 frequency dividing output	Terminal wiring

C.2 Physical Appearance



MD38PG1



MD38PG5

Note

- Install/Remove the PG card on the condition that the AC drive is switched off completely.
- Connect the PG card to the J21 on the main control board by using the 18-pin FFC (make sure of proper installation and buckling the card in place).

■ Description of Terminals and Jumpers

The following table describes the specification, terminals and jumpers of the PG cards.

MD38PG1 Specification		
User interface	Oblique terminal block	
Clearance	3.5 mm	
Screw	Flathead	
Pluggable	No	
Cable specification	16 to 26 AWG	
Max. frequency	500 kHz	
Differential input limit	≤ 7 V	
MD38PG1 Terminals		
No.	Mark	Description
1	A+	Encoder output signal A positive
2	A-	Encoder output signal A negative
3	B+	Encoder output signal B positive
4	B-	Encoder output signal B negative
5	Z+	Encoder output signal Z positive
6	Z-	Encoder output signal Z negative
7	5V	Provide 5 V/100 mA power supply externally
8	COM	Power ground
9	PE	Shield connecting point



MD38PG5 Specification

User interface	Oblique terminal block
Clearance	3.5 mm
Screw	Flathead
Pluggable	No
Cable specification	16 to 26 AWG
Max. frequency	100 kHz

MD38PG5 Terminals

No.	Mark	Description
1	A	Encoder output signal A
2	B	Encoder output signal B
3	Z	Encoder output signal Z
4	15V	Provide 5 V/100 mA power supply externally
5	COM	Power ground
6	COM	Power ground
7	A1	PG card frequency dividing (1:1) output signal A
8	B1	PG card frequency dividing (1:1) output signal B
9	PE	Shield connecting point

MD38PG5 Jumpers

J3, J4	Jumper Position	Description
	Shorting pins 2 and 3	Supporting the "pulse + direction" function
	Shorting pins 1 and 2	Not supporting the "pulse + direction" function (default setting)

Appendix D Damage Notification Report

Company/Address: _____

Customer Information: _____

Personal Information (Name/Tel/Fax): _____

Inovance Medium-Voltage AC Drive Model: _____

Inovance Medium-Voltage AC Drive Manufacturing SN: _____

Damage Location: _____

Damage Date: _____ And/Or Discovery Date: _____

Obvious Damage to Packing: _____

Damage Description:

Customer Signature: _____ Date: _____

Transportation Company Signature _____ Date: _____

Return this report to:

No.16 Youxiang Road, Yuexi,
Wuzhong Economic Development Zone, Suzhou 215000, P.R.China
Suzhou Inovance Technology Co., Ltd.
Fax: 0512-62856720-1214

Version Change Record

Date	Version	Change
Jan. 2015	V0.0	First Issue
Aug. 2018	A01	<ul style="list-style-type: none">• Update Inovance's Logo• Delete 2.1 Description of Functions and 2.2 Applications of Chapter 2 Product Information

INOVANCE Warranty Agreement

1. Inovance provides 18-month free warranty to the equipment itself from the date of manufacturing for the failure or damage under normal use conditions.
2. Within the warranty period, maintenance will be charged for the damages caused by the following reasons:
 - a. Improper use or repair/modification without prior permission
 - b. Fire, flood, abnormal voltage, other disasters and secondary disasters
 - c. Hardware damage caused by dropping or transportation after procurement
 - d. Improper operations
 - e. Damage out of the equipment (for example, external device factors)
3. The maintenance fee is charged according to the latest Maintenance Price List of Inovance.
4. If there is any problem during the service, contact Inovance's agent or Inovance directly.
5. This agreement shall be interpreted by Inovance.
6. Inovance reserves the rights for explanation of this agreement.

Suzhou Inovance Technology Co., Ltd.

Address: No.16, Youxiang Road, Yuexi Town, Wuzhong District, Suzhou 215104, P.R. China

Website: <http://www.inovance.cn/es>

Shenzhen Inovance Technology Co., Ltd.

Add.: Building E, Hongwei Industry Park, Liuxian Road, Baocheng No. 70 Zone, Bao' an District, Shenzhen

Tel: +86-755-2979 9595

Fax: +86-755-2961 9897

Service Hotline: 400-777-1260

<http://www.inovance.com>

Suzhou Inovance Technology Co., Ltd.

Add.: No. 16 Youxiang Road, Yuexi Town, Wuzhong District, Suzhou 215104, P.R. China

Tel: +86-512-6637 6666

Fax: +86-512-6285 6720

Service Hotline: 400-777-1260

<http://www.inovance.com>